



[www.eota.eu](http://www.eota.eu)

**EAD 331565-00-0602**

July 2019

European Assessment Document for

# Wedge lock washers for structural bolting assemblies



The reference title and language for this EAD is English. The applicable rules of copyright refer to the document elaborated in and published by EOTA.

This European Assessment Document (EAD) has been developed taking into account up-to-date technical and scientific knowledge at the time of issue and is published in accordance with the relevant provisions of Regulation No (EU) 305/2011 as a basis for the preparation and issuing of European Technical Assessments (ETA).

## Contents

<b>1</b>	<b>Scope of the EAD</b> .....	<b>4</b>
1.1	Description of the construction product	4
1.2	Information on the intended use(s) of the construction product	5
1.2.1	Intended use(s).....	5
1.2.2	Working life/Durability.....	5
<b>2</b>	<b>Essential characteristics and relevant assessment methods and criteria</b> .....	<b>7</b>
2.1	Essential characteristics of the product	7
2.2	Methods and criteria for assessing the performance of the product in relation to essential characteristics of the product	7
2.2.1	Dimensions.....	7
2.2.2	Hardness of wedge lock washers.....	8
2.2.3	Securing effect.....	8
2.2.4	Preloading .....	10
2.2.5	Reaction to fire .....	10
2.2.6	Durability/Corrosion resistance .....	10
<b>3</b>	<b>Assessment and verification of constancy of performance</b> .....	<b>11</b>
3.1	System(s) of assessment and verification of constancy of performance to be applied	11
3.2	Tasks of the manufacturer	11
3.3	Tasks of the notified body	12
3.4	Special methods of control and testing used for the assessment and verification of constancy of performance	13
3.4.1	Hardness testing.....	13
3.4.2	Characteristics of the coating (if existing) .....	13
3.4.3	Functionality test.....	13
<b>4</b>	<b>Reference documents</b> .....	<b>14</b>
	<b>ANNEX A - Determination of tightening parameters for preloading of bolting assemblies with wedge lock washers</b> .....	<b>15</b>

## 1 SCOPE OF THE EAD

### 1.1 Description of the construction product

The wedge lock washers for structural bolting assemblies (in the following referred to as wedge lock washers) are self-retaining washers to be integrated in a bolting assembly. Such washer prevents the loosening of bolted joints being exposed to dynamic loads or vibrations.

A wedge lock washer consists of two identical pieces with radial ribs or teeth on the outer surface and radial wedges on the inner surface (Figure 1.1.1). Usually, the wedge lock washers are provided preassembled with pieces fixed (e.g., glued) in the correct position (Figure 1.1.2).

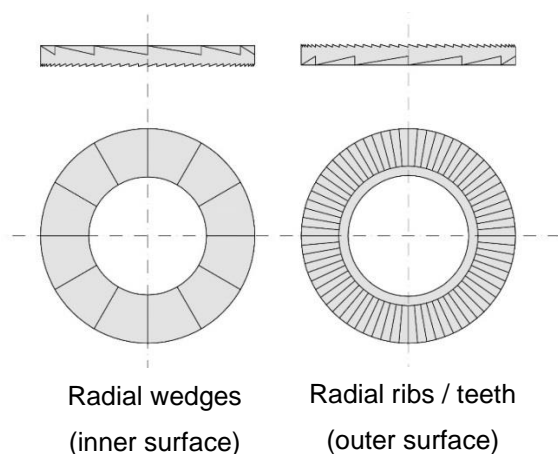

**Figure 1.1.1**

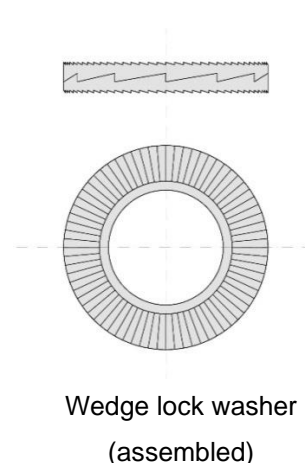

**Figure 1.1.2**

The geometry of the wedge lock washers is intended to suit the relevant size of bolt head or nut. Therefore, the dimension of the wedge lock washer (two pieces assembled) is usually comparable to the conventional non-securing washer used for the respective joint, e.g. similar inner and outer diameter. They may have chamfers on one or both sides of the inner diameter to avoid contact with an under-head-radius of certain bolts. The wedge lock washers are intended to be used with bolts and nuts (not subject to this EAD) the hardness of which is lower than the hardness of the wedge lock washer. The same applies for the surface of the clamping package.

As the bolt and/or nut is tightened, the mating surfaces on the wedge lock washers lock on due to the serrated outer surfaces on them. Thus, rotational displacement between the connected parts is only possible over the inner radial wedges. As soon as the nut and/or the bolt is subjected to self-loosen the wedge lock washer prevents the nut and/or the bolt from self-rotating. The main securing effect is achieved by a greater angle  $\alpha$  of the wedges than the angle of the thread pitch  $\beta$  (Figure 1.2.1.1). As the bolted joint becomes loose (rotational displacement) the wedge induce a greater axial expansion as the thread and the preload increases. The wedge lock washer positively locks the fastener in the joint that is subjected to vibration or dynamic loads.

The wedge lock washers are made of carbon, alloyed steel or high-alloyed steel (e.g., stainless steel). A correct performance is only given if the surface hardness of the wedge lock washer exceeds the surface hardness of the common steel grades used in constructional steel work and of the structural bolt assembly being used. Washers made from carbon steel are coated for corrosion protection.

The product is not covered by a harmonised European standard (hEN).

Concerning product packaging, transport, storage, maintenance, replacement and repair it is the responsibility of the manufacturer to undertake the appropriate measures and to advise his clients on the transport, storage, maintenance, replacement and repair of the product as he considers necessary.

It is assumed that the product will be installed according to the manufacturer's instructions or (in absence of such instructions) according to the usual practice of the building professionals.

Relevant manufacturer's stipulations having influence on the performance of the product covered by this European Assessment Document shall be considered for the determination of the performance and detailed in the ETA.

## 1.2 Information on the intended use(s) of the construction product

### 1.2.1 Intended use(s)

Depending on the type, wedge lock washers are intended to be used in high strength bolting assemblies for preloading in accordance with EN 14399-1<sup>1</sup> as well as in non-preloaded structural bolting assemblies in accordance with EN 15048-1. Furthermore, the washers are intended to be used in single bolt joints like threaded blind holes. The usage with larger bolt sizes than given in the named standards is not excluded.

The wedge lock washers are intended to be used instead of the conventional washers of a bolting assembly, whereby a wedge lock washer is required under the bolt head and/or the nut. In bolt-nut assemblies it is intended to be applied on both sides.

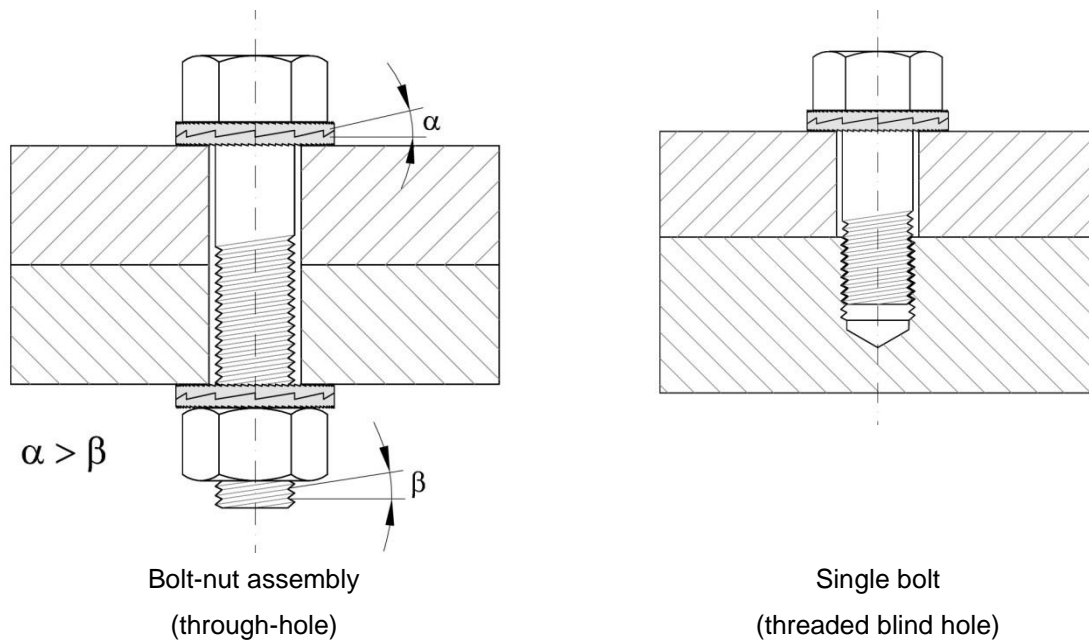

Figure 1.2.1.1

The wedge lock washers are intended to be used in joints of metal members with a surface hardness (in contact area) lower than the washer's hardness. To ensure the washer's intended securing effect on the joint, both a sufficient difference in hardness as well as suitable properties of possibly applied coatings (e.g., composition, thickness) need to be considered.

### 1.2.2 Working life/Durability

The assessment methods included or referred to in this EAD have been written based on the manufacturer's request to take into account a working life of the wedge lock washers for the intended use of 25 years when

<sup>1</sup> All undated references to standards or to EADs in the text of this EAD are to be understood as references to the dated versions listed in chapter 4.

installed in the works (provided that the wedge lock washers are subject to appropriate installation (see 1.1)). These provisions are based upon the current state of the art and the available knowledge and experience.

When assessing the product, the intended use as foreseen by the manufacturer shall be taken into account. The real working life may be, in normal use conditions, considerably longer without major degradation affecting the basic requirements for works<sup>2</sup>.

The indications given as to the working life of the construction product cannot be interpreted as a guarantee neither given by the product manufacturer or his representative nor by EOTA when drafting this EAD nor by the Technical Assessment Body issuing an ETA based on this EAD, but are regarded only as a means for expressing the expected economically reasonable working life of the product.

---

<sup>2</sup> The real working life of a product incorporated in a specific works depends on the environmental conditions to which that works is subject, as well as on the particular conditions of the design, execution, use and maintenance of that works. Therefore, it cannot be excluded that in certain cases the real working life of the product may also be shorter than referred to above.

## 2 ESSENTIAL CHARACTERISTICS AND RELEVANT ASSESSMENT METHODS AND CRITERIA

### 2.1 Essential characteristics of the product

Table 2.1.1 shows how the performance of the wedge lock washer is assessed in relation to the essential characteristics.

**Table 2.1.1 Essential characteristics of the product and methods and criteria for assessing the performance of the product in relation to those essential characteristics**

No	Essential characteristic	Assessment method	Type of expression of product performance
<b>Basic Works Requirement 1: Mechanical resistance and stability</b>			
1	Dimensions	2.2.1	Level
2	Hardness of wedge lock washers	2.2.2	Level
3	Securing effect	2.2.3	Description
4	Preloading	2.2.4	Level
<b>Basic Works Requirement 2: Safety in case of fire</b>			
5	Reaction to fire	2.2.5	Class
<b>Aspects of durability</b>			
6	Durability/ Corrosion resistance	2.2.6	Level/Description

The test results depend on the character of the constructional steel work (e.g., material, coating composition, thickness of coating), the bolting assemblies (e.g., strength, thread, nominal diameter, coating) and the wedge lock washers (e.g., thickness, outer diameter, inner diameter, material, angle of the wedges). Due to this, tests shall be performed for each combination and given in the ETA.

### 2.2 Methods and criteria for assessing the performance of the product in relation to essential characteristics of the product

This chapter is intended to provide instructions for TABs. Therefore, the use of wordings such as “shall be stated in the ETA” or “it has to be given in the ETA” shall be understood only as such instructions for TABs on how results of assessments shall be presented in the ETA. Such wordings do not impose any obligations for the manufacturer and the TAB shall not carry out the assessment of the performance in relation to a given essential characteristic when the manufacturer does not wish to declare this performance in the Declaration of Performance.

#### 2.2.1 Dimensions

Dimensions shall be measured for at least ten wedge lock washers (each product type) in accordance with EN 14399-1, clause 5.4.3, arithmetic average of characteristics below shall be given in the ETA:

- Outer diameter;
- Hole Diameter;
- Thickness of a single washer:

A pair of wedge lock washers shall be separated and thickness of a single washer including radial wedges and ribs/teeth measured;

- Thickness of a pair of washers:

A pair of wedge lock washers shall not be separated and thickness of wedge lock washers as intended to be used with ribs/teeth on both sides shall be measured. Measurement shall be carried out on an unglued pair of washers with full contact of the two single washers to each other without a gap between them;

- Chamfer (if existing);
- Number of radial wedges (inner surface);
- Number of radial ribs / teeth (outer surface).

### 2.2.2 Hardness of wedge lock washers

Vickers hardness shall be measured in accordance with EN ISO 6507-1 for at least five single washers of different wedge lock washer pairs. The Vickers hardness shall be measured on the cross-section of the washers, see Figure 2.2.2.1. The measurement shall be performed at least at four points with a minimum radial distance from the outer edges of the washer specified in EN ISO 6507-1. The surface preparation shall be carried out according to EN ISO 6507-1. The hardness of the wedge lock washers shall be given in the ETA.

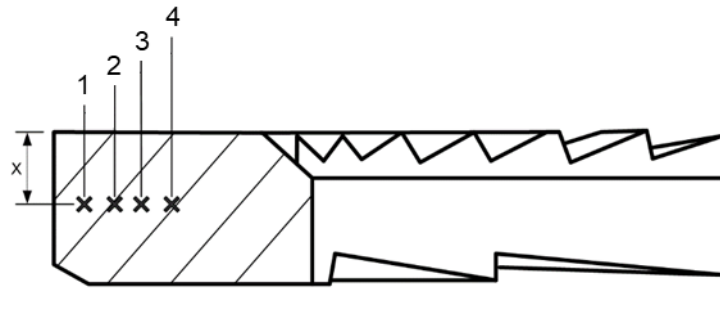

Figure 2.2.2.1 Cross-section of wedge lock washer

### 2.2.3 Securing effect

The securing effect shall be proven for wedge lock washers in combination with either bolting assemblies according to EN 15048-1 or EN 14399-1 for each property class and diameter for which the ETA shall be valid.

The securing effect is present if a sufficient clamp force is applied to ensure the form-fit of the radial teeth into the bearing surfaces and to enable the wedge effect during disassembly which results in a preload increase due to additional elongation of the bolt.

Conditions, essential for the test procedure, are listed below:

- Bolt, nut:  
Threads shall be free from defects to provide proper tightening condition. Description of bolt and nut shall be given in the ETA. Nut and bolt need to be part of the same bolt assembly; washers shall be replaced with wedge lock washers.
- The surface preparation and the hardness of the surface of the clamping package shall be specified in the ETA.

The securing effect shall be proven for preloaded and non-preloaded bolting assemblies by torque/clamp force testing. The torque/clamp force test shall be conducted to determine the clamp force and its scatter in order to define the required torque to achieve the securing effect. The test for the determination of the form-fit and the wedge effect is iterative. At least 10 bolting assemblies shall be used for each iteration.



The form-fit is achieved, when indentations on the bearing surfaces of the bolt, the nut and the clamping package are visually perceptible, see Figure 2.2.3.1. This shall be checked by visual testing for at least ten bolting assemblies of each size and product type.

The illuminance on the surface with white light shall be at least 350 lx. However, 500 lx is recommended. For visual inspection, the eye shall be within 600 mm of the surface to be inspected. For the visual inspection, the bearing surfaces of the bolts, nuts and components shall be viewed at an angle of not less than 30° (see Figure 2.2.3.1).

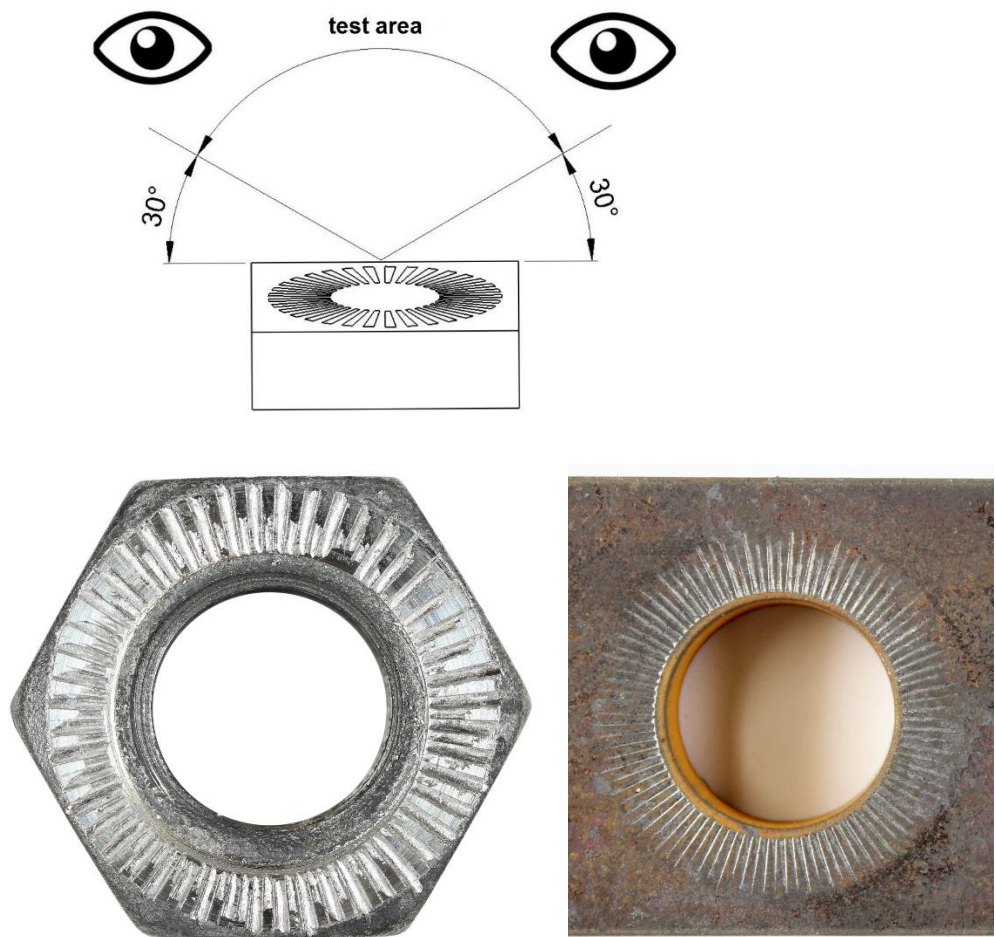

**Figure 2.2.3.1 Visual inspection of the form-fit**

The wedge effect takes place during disassembly and shall result in a preload increase. Due to the form-fit between the radial teeth and the bearing surfaces, rotation during disassembly is only possible over the inner wedges (see figure 2.2.3.2). Consequently, the preload has to be increased in the beginning of disassembly if the wedge angle is larger than the thread pitch angle. The preload increase shall be assessed from the preload curves during disassembly.

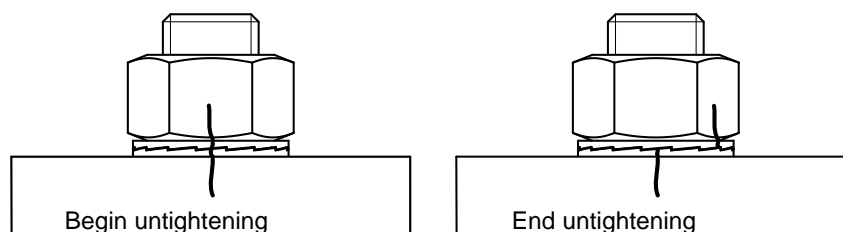

**Figure 2.2.3.2: Untightening process – relative movement between the washers**

The tightening torque, which is needed for non-preloaded and preloaded bolting assemblies with wedge lock washers to ensure the securing effect, shall be specified in the ETA. The assessment is based on the assumption that this tightening torque is at least the 95 % fractile of the tightening torques which are needed to achieve the form-fit connection and the wedge effect of the tested bolting assemblies including the wedge lock washers.

#### 2.2.4 Preloading

The suitability of the wedge lock washers for high-strength structural bolting assemblies for preloading according to EN 14399-1 shall be tested in accordance with EN 14399-2, clauses 6.2 and 6.4 to 6.7. The test procedure is described in EN 14399-2, clauses 6.2, 6.4 and 6.5, the test evaluation in EN 14399-2, clause 6.6, and the test documentation in EN 14399-2, clause 6.7. If equal bolting assemblies and wedge lock washers with varying nominal diameters are tested, the evaluation of all tests is necessary for each diameter. The evaluation of the tests shall be carried out according to Annex A.

Each part of a bolting assembly shall be used only once.

The performance is defined by tightening parameters (preload force, tightening torque) which are specified in the ETA.

#### 2.2.5 Reaction to fire

The product shall be classified in accordance with Commission Delegated Regulation (EU) No 2016/364. The wedge lock washer is considered to satisfy the requirements for performance class A1 of the characteristic reaction to fire in accordance with the Commission Decision 96/603/EC, as amended by Commission Decisions 2000/605/EC and 2003/424/EC, without the need for testing on the basis of it fulfilling the conditions set out in that decision and its intended use being covered by that decision.

Therefore, the performance of the product is class A1.

#### 2.2.6 Durability/Corrosion resistance

If comprised by the description in one of the standards listed below, the materials, where the wedge lock washers are made from, including a possibly applied coating shall be assessed for their applicability in corrosive atmospheres in accordance with:

EN 1993-1-3, Annex B (equal to EN 1999-1-4, Annex B)	and/or
EN ISO 14713-1	or
EN 1993-1-4, Table A.3 + A.4	or
EN ISO 12944-5	

It shall be taken into account that when the wedge lock washer is coated, this assessment is only appropriate if the protection effect is still present after the assembling process (e.g., sufficient adhesion or cathodic protection).

If the material and/or the coating composition are not comprised by one of the standards, their precise trade names and the relevant specifications shall be indicated. The designation of stainless steel in accordance with EN 10088-1 shall be stated in the ETA.

### 3 ASSESSMENT AND VERIFICATION OF CONSTANCY OF PERFORMANCE

#### 3.1 System(s) of assessment and verification of constancy of performance to be applied

For the products covered by this EAD the applicable European legal act is Commission Decision 98/214/EC, as amended by Decision 2001/596/EC.

The system is **2+**.

#### 3.2 Tasks of the manufacturer

The cornerstones of the actions to be undertaken by the manufacturer of the product in the procedure of assessment and verification of constancy of performance are laid down in Table 3.2.1.

**Table 3.2.1 Control plan for the manufacturer; cornerstones**

No	Subject/type of control	Test or control method	Criteria, if any	Minimum number of samples	Minimum frequency of control
<b>Factory production control (FPC)</b> [including testing of samples taken at the factory in accordance with a prescribed test plan]					
1	Check of material properties and chemical composition stated in the ETA	Inspection document 3.1. according to EN 10204 (to be furnished by the supplier)	Control plan	-	Every production unit
2	Dimensions	Check of dimensions and tolerances	Control plan	10	Every production unit
3	Hardness	3.4.1	Control plan	5	Every production unit
4	Surface treatment (e.g., galvanising, zinc plating)	3.4.2	Control plan	Control plan	Every production unit
5	Functionality test	3.4.3	Control plan	Control plan	Every production unit

### 3.3 Tasks of the notified body

The cornerstones of the actions to be undertaken by the notified body of the product in the procedure of assessment and verification of constancy of performance are laid down in Table 3.3.1.

**Table 3.3.1 Control plan for the notified body; cornerstones**

No	Subject/type of control	Test or control method	Criteria, if any	Minimum number of samples	Minimum frequency of control
<b>Initial inspection of the manufacturing plant and of factory production control</b>					
1	Ascertain that the factory production control with the staff and equipment are suitable to ensure a continuous and orderly manufacturing of the wedge-lock washers.	Verification of the complete FPC, to be implemented by the manufacturer	Laid down in control plan	-	When starting the production or a new production line
<b>Continuous surveillance, assessment and evaluation of factory production control</b>					
2	Verifying that the system of factory production control and the specified automated manufacturing process are maintained taking account of the control plan.	Verification of the controls carried out by the manufacturer on the raw materials, on the process and on the product as indicated in Table 3.2.1	Laid down in control plan	-	Once per year

### 3.4 Special methods of control and testing used for the assessment and verification of constancy of performance

#### 3.4.1 Hardness testing

For hardness testing, the Vickers test method according to EN ISO 6507-1 shall be used. All parameters important for testing like the surface preparation, point of measurement, the proof load, the used scale or indenter shall be determined.

#### 3.4.2 Characteristics of the coating (if existing)

When performing the coating process the compounding of the varnish respectively the composition of the melted bath of metallic coatings shall be regularly checked. The conformity of the intended coating can be shown by a document equivalent to an inspection certificate 3.1 in accordance with EN 10204.

The coating thickness shall be measured by means of a method appropriate in consideration of the coating type. When determining the prospective method, EN ISO 10683, clause 7.3, shall be taken into account for zinc flake coatings. Furthermore, suitable destructive and non-destructive methods are described in EN ISO 2808 regarding organic coatings (paints and varnishes) and EN ISO 3882 regarding metallic coatings (e.g., electroplated coatings).

#### 3.4.3 Functionality test

The functionality test is a simple method to verify the securing effect on the bolted joints. For this purpose, the nut or the bolt head and the bearing part have to be marked after tightening with the specified assembly torque (see Figure 3.4.3.1) to indicate any relative movement between the different parts. This confirms that the relative movement during untightening has only taken place between the two wedge lock washers and not over the bearing and/or bolt or nut surface. If the untightening process does not work correctly, the tested wedge lock washer fails the test.

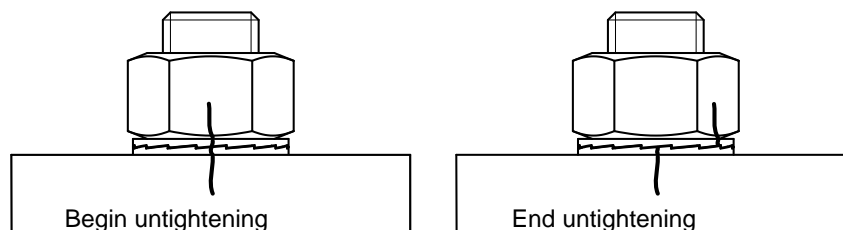

Figure 3.4.3.1: Functionality test, marker for untightening process, functionality test

## 4 REFERENCE DOCUMENTS

EN 10088-1:2014	Stainless steels - Part 1: List of stainless steels
EN 10204:2004	Metallic products - Types of inspection documents
EN 14399-1:2015	High-strength structural bolting assemblies for preloading - Part 1: General requirements
EN 14399-2:2015	High-strength structural bolting assemblies for preloading - Part 2: Suitability for preloading
EN 15048-1:2016	Non-preloaded structural bolting assemblies - Part 1: General requirements
EN 1993-1-3:2006 + AC:2009	Eurocode 3: Design of steel structures - Part 1-3: General rules - Supplementary rules for cold-formed members and sheeting
EN 1993-1-4: 2006 + A1:2015	Eurocode 3: Design of steel structures - Part 1-4: General rules - Supplementary rules for stainless steels
EN ISO 14713-1:2017	Zinc coatings - Guidelines and recommendations for the protection against corrosion of iron and steel in structures - Part 1: General principles of design and corrosion resistance (ISO 14713-1:2017)
EN 1999-1-4:2010-05	Eurocode 9 - Design of aluminium structures - Part 1-4: Cold-formed structural sheeting
EN ISO 10683:2018	Fasteners – Non-electrolytically applied zinc flake coating systems (ISO 10683:2018)
EN ISO 2808:2019	Paints and varnishes - Determination of film thickness (ISO 2808:2019)
EN ISO 3882:2003	Metallic and other inorganic coatings - Review of methods of measurement of thickness (ISO 3882:2003)
EN ISO 6507-1:2018	Metallic materials - Vickers hardness test - Part 1: Test method (ISO 6507-1:2018)
EN ISO 12944-5:2019	Paints and varnishes - Corrosion protection of steel structures by protective paint systems - Part 5: Protective paint systems (ISO 12944-5:2019)

## ANNEX A DETERMINATION OF TIGHTENING PARAMETERS FOR PRELOADING OF BOLTING ASSEMBLIES WITH WEDGE LOCK WASHERS

For the determination of preloading parameters, suitability tests shall be performed in accordance with EN 14399-2. Based on these suitability tests, the following parameters are to be determined and evaluated for the determined tightening parameters (tightening torque, angle of rotation etc.) in accordance with Table A.1:

- $F_{tpi}$  the individual value of the bolt force related to the considered tightening parameter (tightening torque, angle of rotation etc.).
- $F_{tp,min}$  the minimum value of all  $F_{tpi}$  values.
- $F_{tp,max}$  the maximum value of all  $F_{tpi}$  values.
- $F_{tp,m}$  the mean value of all  $F_{tpi}$  values.
- $F_{tp,5\%}$  the 5 % fractile of all  $F_{tpi}$  values.
- $F_{tp,95\%}$  the 95 % fractile of all  $F_{tpi}$  values.

For the determination of tightening parameters, at least 10 bolting assemblies shall be tested for each diameter to be assessed.

It is necessary to confirm that the preload in the bolting assembly is reliably applied. For this reason, tightening parameters shall be defined which fulfil the limiting criteria No. 1 to 3 given in Table A.1.

The limiting criteria 4T and 5T shall be fulfilled if a torque controlled tightening method is used.

The limiting criterion 4C shall be fulfilled if a combined tightening method is used.

**Table A.1 – Criteria for the determination of tightening parameters**

No.	Limiting criteria to be fulfilled, when evaluated tightening parameters are applied <sup>a</sup>	
<b>Criteria to ensure the minimum value of preload <math>F_p</math> is reliably applied</b>		
1	The lowest individual preload $F_{tp,min}$ from one test series shall exceed the required minimum preload $F_b$ by at least 3 %	$F_{tp,min} \geq 1,03 F_p$
2	The 5 % fractile of the individual preload $F_{tp,5\%}$ from one test series shall exceed the required minimum preload $F_b$ by at least 3 %	$F_{tp,5\%} \geq 1,03 F_p$
3	The mean value of the individual preload $F_{tp,m}$ from one test series shall exceed the required minimum preload $F_b$ by at least 10 %	$F_{tp,m} \geq 1,1 F_p$
<b>Criteria to avoid overtightening of the bolting assembly components up to fracture when evaluating parameters for a <u>torque controlled tightening method</u></b>		
4T	The 95 % fractile of the individual preload $F_{tp,95\%}$ of one test series shall be less than or equal to 95 % of the minimum value of all $F_{b,max}$ values within a test series	$F_{tp,95\%} \leq 0,95 F_{b,max,min}$
5T	The highest individual preload $F_{tp,max}$ of one test series shall be less than or equal to 95 % of the minimum value of all $F_{b,max}$ values within a test series	$F_{tp,max} \leq 0,95 F_{b,max,min}$
<b>Criteria to avoid overtightening of the bolting assembly components up to fracture when evaluating parameters for a <u>combined tightening method</u></b>		
4C	The individual preload $F_{tpi}$ shall not exceed the maximum preload $F_{bi,max}$ within a single test	$F_{tpi} < F_{bi,max}$
<sup>a</sup> The limiting criteria given in this table shall ensure, that with the evaluated tightening parameters, the desired preload is applied in the bolting assembly and overtightening is prevented		

The tightening parameters (bolt preload achieved in tightening tests) are determined by considering the 5 % and 95 % fractile values, assuming a normal distribution of the test results with unknown coefficients of variation according to EN 1990, Annex D 7.2.

$$F_{tp,5\%} = F_{tp,m} \cdot (1 - k_n \cdot V_F) \quad (A.1)$$

$$F_{tp,95\%} = F_{tp,m} \cdot (1 + k_n \cdot V_F) \quad (A.2)$$

with

$$F_{tp,m} = \frac{\sum F_{tpi}}{n} \quad (A.3)$$

$$V_F = \frac{s_F}{F_{b,m}} \quad (A.4)$$

$$s_F = \sqrt{\frac{1}{n-1} \cdot \sum (F_{tpi} - F_{tp,m})^2} \quad (A.5)$$

$k_n$  is the quantile factor an unknown coefficient of variation according to EN 1990, Annex D,

$n$  is the amount of test results within a test series,

$s_F$  is the calculated standard deviation of the  $F_{bi}$  values,

$V_F$  is the calculated coefficient of variation of the  $F_{bi}$  values.