



## EUROPEAN ASSESSMENT DOCUMENT

EAD 050001-00-0301

February 2018

# LOAD BEARING THERMAL INSULATING ELEMENTS WHICH FORM A THERMAL BREAK BETWEEN BALCONIES AND INTERNAL FLOORS

The reference title and language for this EAD is English. The applicable rules of copyright refer to the document elaborated in and published by EOTA.

This European Assessment Document (EAD) has been developed taking into account up-to-date technical and scientific knowledge at the time of issue and is published in accordance with the relevant provisions of Regulation (EU) No 305/2011 as a basis for the preparation and issuing of European Technical Assessments (ETA).

## Contents

<b>1</b>	<b>Scope of the EAD</b> .....	<b>4</b>
1.1	Description of the construction product	4
1.1.1	General.....	4
1.1.2	Load bearing components.....	5
1.1.3	Ancillary components .....	6
1.2	Information on the intended use of the construction product	7
1.2.1	Intended use.....	7
1.2.2	Working life / Durability.....	7
1.3	Specific terms used in this EAD	7
1.3.1	Materials.....	7
1.3.2	Symbols.....	8
<b>2</b>	<b>Essential characteristics and relevant assessment methods and criteria</b> .....	<b>10</b>
2.1	Essential characteristics of the product	10
2.2	Methods and criteria for assessing the performance of the product in relation to essential characteristics of the product	10
2.2.1	Load bearing capacity .....	10
2.2.2	Reaction to fire .....	12
2.2.3	Resistance to fire.....	12
2.2.4	Impact sound insulation.....	12
2.2.5	Thermal resistance.....	13
<b>3</b>	<b>Assessment and verification of constancy of performance</b> .....	<b>15</b>
3.1	System of assessment and verification of constancy of performance to be applied	15
3.2	Tasks of the manufacturer	15
3.3	Tasks of the notified body	17
<b>4</b>	<b>Reference documents</b> .....	<b>18</b>
<b>Annex A</b>	<b>Testing requirements</b> .....	<b>20</b>
<b>Annex B</b>	<b>Structural models and calculation methods</b> .....	<b>27</b>
<b>Annex C</b>	<b>Freeze thaw resistance</b> .....	<b>36</b>

# 1 SCOPE OF THE EAD

## 1.1 Description of the construction product

### 1.1.1 General

This EAD is applicable for load bearing thermal insulating elements (LBTIE) used to connect structural reinforced concrete members such as a main slab and balcony by linear support. The LBTIE consist of load bearing elements and insulating material.

There are examples for the following different types of LBTIE:

#### ***LBTIE for transfer of bending moments and shear forces:***

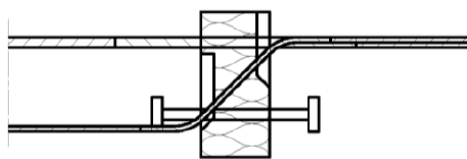

Figure 1.1: Compression element consisting of steel

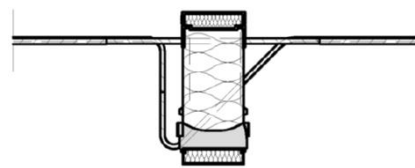

Figure 1.2: Compression element consisting of concrete or high performance mortar

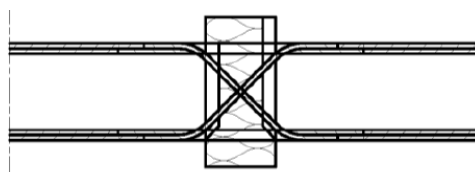

Figure 1.3: Bending moments and shear forces (in both directions), compression element consisting of steel

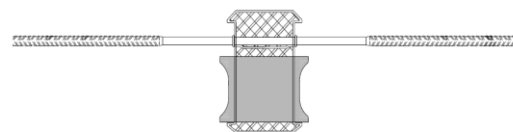

Figure 1.4: Compression shear bearing consisting of concrete or high performance mortar

#### ***LBTIE for transfer of shear forces only:***

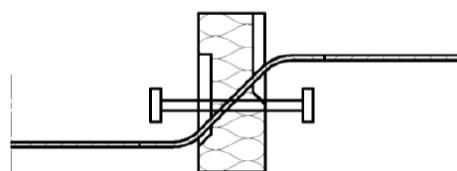

Figure 1.5: Compression element consisting of steel

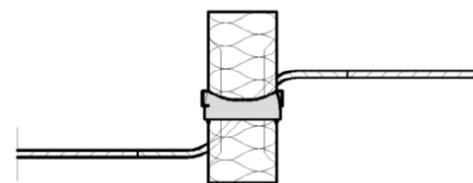

Figure 1.6: Compression element consisting of concrete or high performance mortar

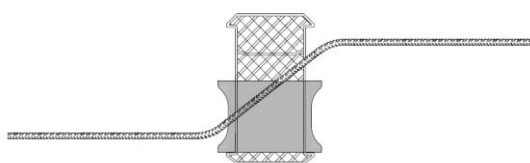

Figure 1.7: Compression shear bearing consisting of concrete or high performance mortar

The product is not covered by a harmonised European standard (hEN).

Concerning product packaging, transport, storage, maintenance, replacement and repair it is the responsibility of the manufacturer to undertake the appropriate measures and to advise his clients on the transport, storage, maintenance, replacement and repair of the product as he considers necessary.

It is assumed that the product will be installed according to the manufacturer's instructions or (in absence of such instructions) according to the usual practice of the building professionals.

Relevant manufacturer's stipulations having influence on the performance of the product covered by this European Assessment Document, shall be considered for the determination of the performance and detailed in the ETA.

### 1.1.2 Load bearing components

The load bearing components transfer tension, compression or shear forces.

The load bearing steel components passing through the thermal insulation material and the adjacent concrete members without sufficient concrete cover are:

- bars in stainless steel along its entire length or
- bars in stainless steel extends at least 10 cm at both ends in the adjacent concrete (common reinforcing steel is butt welded at the ends of the stainless steel bar) or
- compression bar in stainless steel with a transverse set-on common steel end plate, the stainless steel extends at least 5 cm in the adjacent concrete or
- compression bar in stainless steel with a transverse set-on stainless steel end plate or
- sleeve in stainless steel around the steel and completely filling the annular void between steel and sleeve with resin.

This EAD covers LBTIE with the following components:

#### *Tension reinforcement*

Reinforcing steel conform to EN 1992-1-1, Table C.1

Stainless reinforcing steel conform to EN 1992-1-1, Table C.1 and  $450 \text{ MPa} \leq R_{e, \text{nom}} \leq 900 \text{ MPa}$  and according to EN 1993-1-4, Annex A, Table A.3, corrosion resistance class III or material number 1.4482 according to EN 10088-3 with effective sum > 23

The use of high strength stainless reinforcing bars up to tensile yield strength of 900 MPa is possible in the joint and up to 100 mm into adjacent concrete members.

Diameter	$6 \leq \phi \leq 20 \text{ mm}$	
Number per metre	$n \geq 2/\text{m}$	$(h \leq 300 \text{ mm})$
	$n \geq 4/\text{m}$	$(h > 300 \text{ mm})$
Axial edge distance	$c_1 \geq 50 \text{ mm}$	

#### *Shear force reinforcement*

Reinforcing steel conform to EN 1992-1-1, Table C.1

Stainless reinforcing steel conform to EN 1992-1-1, Table C.1 and according to EN 1993-1-4, Annex A, Table A.3, corrosion resistance class III or material number 1.4482 according to EN 10088-3 with effective sum > 23

Diameter	$6 \leq \phi \leq 14 \text{ mm}$	
Number per metre	$n \geq 4/\text{m}$	
	combined with CSB	$n \geq 2/\text{m}$ $(6 \leq \phi \leq 8 \text{ mm})$
	$n \geq 4/\text{m}$	$(\phi > 8 \text{ mm})$
Axial edge distance and axial distance	$c_1 \geq 6 \cdot \phi$	$(6 \leq \phi \leq 12 \text{ mm})$
	$c_1 \geq 7 \cdot \phi$ or rather 100 mm	$(\phi \leq 14 \text{ mm})$
Mandrel diameter	$D \geq 6 \cdot \phi$ $(6 \leq \phi \leq 12 \text{ mm})$	

	$D \geq 10 \cdot \phi$ ( $12 < \phi \leq 14$ mm)
Bends start point	$2 \cdot \phi$ inside the concrete
Inclination	$30 \leq \alpha \leq 60^\circ$

**Compression steel bearing**

Reinforcing steel conform to EN 1992-1-1, Table C.1

Stainless reinforcing steel conform to EN 1992-1-1, Table C.1 or stainless steel of the minimum strength class S460 and according to corrosion resistance class III, EN 1993-1-4

Diameter	$6 \leq \phi \leq 20$ mm
Number per metre	$n \geq 4/m$
Axial edge distance	$c_1 \geq 50$ mm

**Steel plate welded to compression bar**

Hot rolled structural steel, at least S235 according to EN 10025-1 and EN 10025-2 or EN 10088-1

**Concrete compression bearing CB**

Suitable shaped element of concrete or high performance mortar with density  $\geq 2000$  kg/m<sup>3</sup>, end faces of the element can be provided with a specific geometry and additional components to facilitate movement between the external and internal slab

Number per metre	$n \geq 4/m$
Axial edge distance	$c_1 \geq 50$ mm
Freeze thaw resistance	$R_{DM,UPTT} \geq 0,85$ and $\Delta_{mn} \leq 10$ %

**Concrete compression shear bearing CSB**

Suitable shaped element of concrete or high performance mortar with density  $\geq 2000$  kg/m<sup>3</sup>, end faces of the element can be provided with a specific geometry and additional components to facilitate movement between the external and internal slab

Number per metre	$2 \leq n \leq 12/m$ and	
	$n \geq 2/m$ ( $h \leq 300$ mm)	
	$n \geq 4/m$ ( $h > 300$ mm)	
Axial edge distance	$c_1 \geq 80$ mm	
Axial distance	$c_1 \geq 75$ mm	
Freeze thaw resistance	$R_{DM,UPTT} \geq 0,85$ and $\Delta_{mn} \leq 10$ %	

**External and internal slab**

Thickness	$160$ mm $\leq h \leq 500$ mm
-----------	-------------------------------

**1.1.3 Ancillary components**

The following ancillary components do not contribute to the load bearing capacity of the LBTIE.

**Stainless steel sleeve with resin filling material**

Stainless steel tube according to EN 10217-7 or EN ISO 1127, with a wall thickness of  $\geq 0,8$  mm and an inner diameter about 4 mm larger than the nominal diameter of the common reinforcing steel

**Thermal insulation material**

Thermal insulation products of expanded polystyrene (EPS) according to EN 13162 or mineral wool (MW) according to EN 13163 or phenolic foam (PF) according to EN 13166

**Fire protection plate**

Fire protection plate conform to the fire protection plate used in the resistance to fire tests according to Clause 2.2.3

**Plastic cover**

The function of the plastic cover is to protect the insulation element of damage.

## 1.2 Information on the intended use of the construction product

### 1.2.1 Intended use

The intended use of the product is the connection of external slabs of reinforced concrete with internal slabs (normal weight concrete of minimum strength C20/25 according to EN 206), e.g. floor slabs of reinforced concrete in buildings over the full length of insulation joint. As external slabs also vertical members like balustrades or parapets can be connected with the product.

The external and internal slabs are not part of the product. In particular the product is intended to be used for:

- to minimize thermal bridges in buildings,
- to transfer static and quasi static bending moments, tension, compression and shear forces,
- included are members subject to fire regulation.

### 1.2.2 Working life / Durability

The assessment methods included or referred to in this EAD have been written based on the manufacturer's request to take into account a working life of the insulating element for the intended use of 50 years when installed in the works. These provisions are based upon the current state of the art and the available knowledge and experience.

When assessing the product the intended use as foreseen by the manufacturer shall be taken into account. The real working life may be, in normal use conditions, considerably longer without major degradation affecting the basic requirements for works<sup>1</sup>.

The indications given as to the working life of the construction product cannot be interpreted as a guarantee neither given by the product manufacturer or his representative nor by EOTA when drafting this EAD nor by the Technical Assessment Body issuing an ETA based on this EAD, but are regarded only as a means for expressing the expected economically reasonable working life of the product.

## 1.3 Specific terms used in this EAD

### 1.3.1 Materials

#### **concrete compression bearing, CB**

concrete element to transfer compression forces via special shaped load bearing surfaces, concrete compression bearing may be in concrete or high strength and fibre reinforced concrete or mortar

#### **concrete compression shear bearing, CSB**

element of high strength fibre reinforced concrete or mortar with capacities to transfer compression and shear forces via special shaped load bearing surfaces

#### **steel compression bearing**

stainless steel bar, common reinforcing steel, or stainless reinforcing steel, compression forces are transferred to the concrete by either bond or welded transverse set-on bar end plate joints, end plates are made of steel or stainless steel

---

<sup>1</sup> The real working life of a product incorporated in a specific works depends on the environmental conditions to which that works is subject, as well as on the particular conditions of the design, execution, use and maintenance of that works. Therefore, it cannot be excluded that in certain cases the real working life of the product may also be shorter than the assumed working life.

### 1.3.2 Symbols

$\alpha$	angle between axes of shear force reinforcement and the horizontal
$\alpha_c$	linear coefficient of thermal expansion
$\alpha_{cc}$	coefficient taking account of long term effects on the compressive strength
$\mu$	water vapour diffusion resistance factor
$\lambda_{eq, TI}$	equivalent thermal conductivity of thermal insulating element
$\sigma$	upper limit of strength in fatigue test
$\Delta L_w$	weighted impact sound reduction index
$\Delta L_{w, TI}$	weighted impact sound reduction of thermal insulation
$\Delta m_n$	water absorption after n freeze thaw cycles
$\Delta T$	temperature difference
$\chi$	reduction factor for relevant buckling mode
$\phi$	value to determine the reduction factor $\chi$
$A_{gt}$	elongation at maximum force
$A_{s, nom}$	nominal cross sectional area of the common reinforcing steel bar
$c_1$	axial edge distance
$CB$	concrete compression bearing
$CSB$	concrete compression shear bearing
$c$	distance to slab surface
$D$	compression bearing, either in steel or in concrete
$f_R$	relative rib area
$F_{lateral}$	force for cyclic displacement test
$k_n$	factors according to EN 1990, table D.1
$L_2, L_3$	distances to the edges of the thermal insulation material
$L_{n, w}$	weighted normalized impact sound pressure level
$m_{28d}$	mass of the specimen at 28 days (after storage under water)
$m_n$	mass of the specimen after n freeze-thaw cycles
$M_u$	moment determined in test
$M_t$	calculated moment
$M_{td}$	moment calculated with design strength values of materials
$n$	number of components per meter
$n$	number of freeze thaw cycles
$RDM_{UPTT, n}$	relative dynamic modulus of elasticity determined with ultrasonic pulse transit time after n freeze thaw cycles
$R_e$	yield strength
$R_{e, nom}$	nominal yield strength of the common reinforcing steel bar
$R_{eq, TI}$	equivalent thermal resistance of thermal insulating element
$R_m$	tensile strength



$R_{m,nom}$	nominal tensile strength of the common reinforcing steel bar
$R_{p,t0,2,act}$	0,2 percent actual yield strength
$R_{p,c0,2,act}$	0,2 percent actual compression yield point
$S_{joint}$	distance of expansion joints
$t_{joint}$	thickness of thermal insulation material
$t_{s,0}$	transmission time measured before freeze-thaw test start
$t_{s,n}$	transmission time after n freeze-thaw cycles
$v_h$	lateral displacement
$V_u$	shear force determined in test
$V_t$	calculated shear force
$V_{td}$	shear force calculated with design strength values of materials
$w_1, w_2, w_3$	elongation value for vertical displacements
$w_4$	elongation value for horizontal displacements in cyclic displacement test
$Z$	tension reinforcement
$Z_Q$	shear reinforcement

## 2 ESSENTIAL CHARACTERISTICS AND RELEVANT ASSESSMENT METHODS AND CRITERIA

### 2.1 Essential characteristics of the product

Table 2.1 shows how the performance of load bearing thermal insulating element is assessed in relation to the essential characteristics.

**Table 2.1 Essential characteristics of the product and methods and criteria for the assessing the performance of the product in relation to those essential characteristics**

No	Essential characteristic	Assessment method	Type of expression of product performance
Basic Works Requirement 1: Mechanical resistance and stability			
1	Load bearing capacity	2.2.1	Level
Basic Works Requirement 2: Safety in case of fire			
2	Reaction to fire	2.2.2	Class
3	Resistance to fire	2.2.3	Description
Basic Works Requirement 5: Protection against noise			
4	Impact sound insulation	2.2.4	$\Delta L_w$
Basic Works Requirement 6: Energy economy and heat retention			
5	Thermal resistance	2.2.5	$R_{eq,TI}$

### 2.2 Methods and criteria for assessing the performance of the product in relation to essential characteristics of the product

#### 2.2.1 Load bearing capacity

In general large scale tests according to Table 2.2 are necessary to verify the structural model according to Annex B. For products intended to transfer bending moments bending tests shall be performed and for products intended to transfer shear forces only shear tests shall be performed.

The tests to be performed are quasi static tests (see Table 2.2, Row 1, 3 to 5) with testing requirements according to Annex A.1. The number of tests shall be carried out for each type of load bearing element (if exist different dimensions of concrete compression bearing).

The lateral displacement due to temperature changes (see Table 2.2, Row 2) shall be tested with cyclic lateral displacement for each region of nominal diameter for which the maximum permitted distance of the joint is to be specified in the ETA (testing requirements according to Annex A.2).

The total deformation of the connected building component results from the deformation of the slab connection in the insulating joint area and the balcony slab. The tests given in Table 2.2 shall be evaluated for stiffness and deformation.

**Table 2.2:** Large scale tests

No	Failure of	Number of tests	Remark
1	Concrete edge failure of the internal or external slab	$\geq 3$	design concept independent on the concrete strength
	or Partially surface pressure	$\geq 3+3$	design concept dependent on the concrete strength $\geq 3$ with minimum concrete strength and $\geq 3$ with maximum calculated concrete strength
2	Thermal actions	$\geq 1$	See Clause A.2
3a	Concrete compression bearings (CB) or concrete compression shear bearings (CSB)	$\geq 1$ or $\geq 3$	One test shall be carried out with concrete strength $\geq C 50/60$ for the slabs, if no failure of CB or CSB, only tests according to table A.1, row 3 are necessary In case of failure of CB or CSB with concrete strength $\leq C 50/60$ or $\leq$ the concrete strength class, which defined in the ETA for the slabs
3b	Steel compression bearing	$\geq 3$	If the buckling load is assessed by calculation or by buckling tests on the steel compression bearings (see the Clause B.2.2.1.3) it is merely a reference test to confirm the assumptions.
4	Tension reinforcement	$\geq 3$ and $\geq 3+3$	Steel failure in test or measuring elongation of tension reinforcement and verification of the design concept and If the anchorage is different from the normative rules tests with a minimum concrete strength shall be performed. If the design concept of anchorage depends on the concrete strength, three further tests on the calculated maximum concrete strength shall be performed.
5	Shear reinforcement	$\geq 3$ and $\geq 3+3$	Steel failure in test or measuring elongation of shear reinforcement and verification of the design concept and If the anchorage is different from the normative rules tests with a minimum concrete strength shall be performed. If the design concept of anchorage depends on the concrete strength, three further tests on the calculated maximum concrete strength shall be performed.

The applicability of the design concept to other thermal insulating elements, e.g. elements without an offset and elements with an offset between external and internal slab, shall be assessed with at least three tests.

## 2.2.2 Reaction to fire

The load bearing thermal insulating element shall be tested using the test methods according to EN 13501-1 and relevant for the corresponding reaction to fire class. The product shall be classified according to Commission Delegated Regulation (EU) No 2016/364.

## 2.2.3 Resistance to fire

The load bearing thermal insulating element shall be tested, using the test method relevant for the corresponding fire resistance class, in order to be classified according to EN 13501-2. Depending on the intended performance criteria, i.e. R, E, I, or REI or any other combination thereof, the corresponding tests shall be performed. The respective test standards are in accordance to EN 1365-2 for floors and EN 1365-5 for balconies.

To prepare the specimen (minimum slab thickness), the principle of the “worst case” is to be considered. The results obtained are then applied to further configurations.

For estimation of the test load the knowledge of the component which leads to failure is important. It can be assumed that under fire exposure the same failure as under normal temperature occurs.

The resistance  $R_{fi}$  shall be calculated on the basis of the actual mean values of material properties  $R_m$ , under consideration of the partial safety factor  $\gamma_m$  of the relevant material which leads to failure. In order to have no restrictions for application the test load  $E_{test} = R_{fi}$  shall be calculated following eq. (2.3) and (2.4) of EN 1992-1-2, 2.4 and according to eq. (2.1).

$$E_{Test} = R_{fi} = \eta_{fi} \cdot \frac{R_m}{\gamma_m} \quad (2.1)$$

$\gamma_m$  partial safety factor of the material which leads to failure

$\eta_{fi} = 0,7$  according to EN 1992-1-2, 2.4.2

The material properties shall be determined at the same time as the testing the load bearing thermal insulating element (for the concrete of the slabs and of the compression bearing, for the reinforcing steel and stainless steel).

The load bearing thermal insulating element shall be classified according to EN 13501-2.

## 2.2.4 Impact sound insulation

### 2.2.4.1 General

The test is performed in comparison between a concrete slab with and without load bearing thermal insulating element according to one of the following methods.

- measuring sound pressure level (Method A),
- measuring of vibration level (Method B).

These two methods are considered as equivalent.

The weighted normalized impact sound pressure level,  $L_{n,w}$ , shall be determined from the measured sound pressure level according to 2.2.4.3 or from the measured vibration level according to 2.2.4.4 in accordance with EN ISO 717-2 for the specimen with and without load bearing thermal insulating element. The difference between both gives the reduction  $\Delta L_{w,T}$  by the load bearing thermal insulating element. This quantity can be treated as a weighted impact sound reduction index  $\Delta L_w$ .

### 2.2.4.2 Specimen

Two concrete slabs are prepared which are identical in dimensions and concrete used. Typical dimensions for Method A are:

- width 1,0 m

- total length ~ 2,4 m, with a length of ~ 1,0 m of the external slab excluding the thickness of the thermal insulating element
- slab thickness 180 mm

Typical dimensions for Method B are:

- width 2,0 m
- total length ~ 3,25 m, with a length of 1,40 m of the external slab and a length of 1,75 m of the internal slab, excluding the thickness of the thermal insulating element
- slab thickness 180 mm
- optionally the test specimen may have two external slabs with one on either side of the internal slab, resulting in a total length of ~ 4,75 m

#### 2.2.4.3 Method A: Measuring sound pressure level

The test is performed in a test facility for laboratory sound insulation measurement according to EN ISO 10140-5. Source and receiving room are separated by an about 24 cm thick masonry wall with a mass of about 450 kg/m<sup>2</sup>. The wall is plastered at least on one side. About 75 cm from the floor the specimen is installed by passing through the wall. Within the wall the specimen is supported on continuous layer of masonry mortar and the gaps between wall and specimen are completely sealed with masonry mortar.

In the source room the external slab including the thermal insulating element of the specimen is protruding. During testing all temporary supports for installation shall be removed and the specimen shall freely cantilever on both ends. For load bearing thermal insulating elements transferring shear forces only, the external slab may be supported by additional elastomeric bearings at the far side of the slab.

Measurement is performed according to EN ISO 10140-3 for both of these test specimens, one with and one without load bearing thermal insulating element.

#### 2.2.4.4 Method B: Measuring vibration level

The internal slab of the specimen is supported on elastomeric bearings, about 50 to 75 cm above the floor. Thereby the thermal insulating element is at the side of the external slab and the internal slab freely cantilevers. For load bearing thermal insulating elements transferring shear forces only, the external slab may be supported by elastomeric bearings at the far side of the slab.

Measurement is performed following EN ISO 16283-2 and EN ISO 10848-1 for both of these test specimens, one with and one without load bearing thermal insulating element. Instead of measuring sound pressure level, the velocity level is measured on the internal slab.

### 2.2.5 Thermal resistance

Thermal resistance shall be calculated according to EN ISO 6946 and EN ISO 10211. The equivalent thermal resistance of thermal insulating element  $R_{eq, TI}$  shall be determined by using numerical methods (e.g. finite element method) and a detailed 3D model of the thermal insulating element for the configuration shown in figure 2.1. The nominal thickness  $d_{n, TI}$  of the thermal insulating element shall be determined and all indentations as well as all protrusions shall be taken into account.

$$R_{cal} = R_{eq, TI} + R_{con} \quad (2.2)$$

$$R_{eq, TI} = R_{cal} - R_{con} = R_{cal} - \frac{0,06 m}{2,3 W / (m * K)} \quad (2.3)$$

$$\lambda_{eq, TI} = \frac{d_{n, TI}}{R_{eq, TI}} \quad (2.4)$$

Where

$d_{n, TI}$  nominal thickness of thermal insulating element

$\lambda_{eq, TI}$  equivalent thermal conductivity of thermal insulating element

$R_{cal}$  calculated thermal resistance for configuration shown in figure 8

$R_{con}$  thermal resistance of concrete

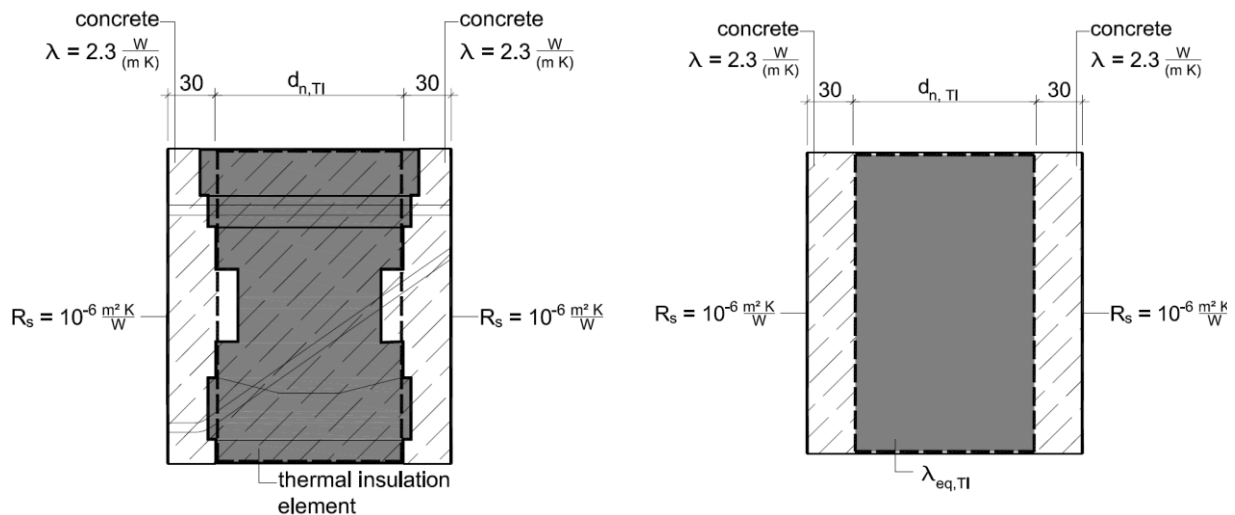

**Figure 2.1:** Cross section of configuration to calculate the equivalent thermal resistance  $R_{eq, TI}$  and simplified analogous model

The thermal conductivity of the components shall be design values. The thermal conductivity taken from EN ISO 10456 or as specified hereafter. The thermal conductivity of the stainless steel elements shall be taken from EN 10088-1.

The value of the thermal conductivity of the thermal insulation material shall be specified according to EN 13162, EN 13163, or the relevant European product standard. The design value is determined according to EN ISO 10456.

The thermal conductivity of materials that are not taken from the documents above-mentioned, e.g. of the concrete compression bearing shall be determined on slab shaped specimens with dimensions appropriate to the equipment according to EN 12664 or EN 12667. This thermal conductivity shall be given as the design value, determined according to EN ISO 10456 from at least 6 individual test results.

### 3 ASSESSMENT AND VERIFICATION OF CONSTANCY OF PERFORMANCE

#### 3.1 System of assessment and verification of constancy of performance to be applied

For the products covered by this EAD the applicable European legal act is: Decision 97/597/EC

The system is: 1+

#### 3.2 Tasks of the manufacturer

The cornerstones of the actions to be undertaken by the manufacturer of the product in the procedure of assessment and verification of constancy of performance are laid down in Table 3.1.

**Table 3.1 Control plan for the manufacturer of the load bearing thermal insulating element; cornerstones**

No	Subject/type of control	Test or control method	Criteria, if any	Minimum number of samples	Minimum frequency of control
<b>Factory production control (FPC) including testing of samples taken at the factory in accordance with a prescribed test plan</b>					
1	Main dimensions	measurement	1)	100 %	100 % <sup>2)</sup>
2	Complete and correct assembly and marking	visual inspection	1)	100 %	100 % <sup>2)</sup>
<b>Primary materials</b>					
3	Materials	Inspection certificate 3.1, test report 2.2 or CE mark	material specification	100 %	100 %
<b>Thermal insulation material</b>					
4	Dimensions, tolerances	measurement	1)	3	each delivery
5	Thermal conductivity	EN 12667	specification	1	4 per year
<b>Tension, compression and shear bar</b>					
6	Dimensions, tolerances	measurement	1)	1	3)
7	Tensile test (only for tension and shear bars)	EN ISO 17660-1	EN ISO 17660-1	1	3)
8	Buckling load (only for compression bars)	B.2.2.1	specification	1	3)
9	Bending test (only for welded bars)	EN ISO 17660-1	no crack	1	3)
10	Complete filling with resin (only for bars with protection sleeve)	visual inspection at 2 perpendicular cuts	complete filling; no voids	1	3)

<b>Steel compression bearing</b>					
11	Dimensions, tolerances	measurement	1)	1	3)
12	Buckling load	B.2.2.1	specification	1	3)
<b>Concrete compression bearing</b>					
13	Dimensions, tolerances	measurement	1)	1	3)
14	Buckling load or compressed-bearing capacity	Table A.1	specification	1	3)
15	Thermal conductivity	EN 12664	specification	1	4 per year
16	Freeze thaw resistance	Annex C	specification	1	at every change of concrete/ mortar composition
<b>Compression shear bearing</b>					
17	Dimensions, tolerances	measurement	1)	1	3)
18	Compressive strength	Table A.1	specification	1	3) respectively 15 per 3 month
19	Flexural strength	Table A.1	specification	1	3) respectively 15 per 3 month
20	Thermal conductivity	EN 12664	specification	1	4 per year
21	Freeze thaw resistance	Annex C	specification	1	at every change of concrete/ mortar composition
<b>Resin filling material</b>					
22	Colour, general appearance	visual examination	uniform	-	each batch
23	Density, Infrared spectrum, Exopy equivalent Amine function Non-volatile-matter content Thermogravimetry Indentation hardness (D Shore hardness)	Inspection certificate 3.1 according to EN 10204	specification	-	each batch
<b>Fire protection plate</b>					
24	Dimensions, tolerances	measurement	specification	1	each batch
25	Thermal conductivity	EN 12664	specification	1	4 per year
<b>All other materials (PVC cover, HDPE, ...)</b>					
22	Dimensions, tolerances	measurement	specification	1	each batch

1) According to the specification and workshop drawing

2) Without documentation of measured values

3) 1 of 1000 load bearing elements, at every change of dimensions



### 3.3 Tasks of the notified body

The cornerstones of the actions to be undertaken by the notified body in the procedure of assessment and verification of constancy of performance for load bearing thermal insulating element are laid down in Table 3.2.

**Table 3.2 Control plan for the notified body; cornerstones**

No	Subject/type of control	Test or control method	Criteria, if any	Minimum number of samples	Minimum frequency of control
<b>Initial inspection of the manufacturing plant and of factory production control</b>					
1	The notified body shall ascertain that, in accordance with the control plan, the manufacturing plant of the product manufacturer, in particular personnel and equipment and the factory production control are suitable to ensure a continuous and orderly manufacturing of the load bearing insulating element according to the ETA.	-	Control plan	-	When starting the production
<b>Continuous surveillance, assessment and evaluation of factory production control</b>					
2	It shall be verified that the system of factory production control and the specified manufacturing process are maintained taking of the control plan.	-	Control Plan	-	2 per year
<b>Audit-testing of samples taken by the notified product certification body at the manufacturing plant or at the manufacturer's storage facilities</b>					
3	Load bearing thermal insulating element - Dimensions, tolerances - Number and dimensions of components - Marking	measurement	<sup>1)</sup>	5 elements	each inspection
4	Components of the load bearing thermal insulating element <sup>2)</sup>	see Table 3.1	see Table 3.1	5 of each component	each inspection
5	Thermal insulation material, concrete compression bearing, compression shear bearing, fire protection plate, and other components of materials that are not listed in EN ISO 10456 or EN ISO 10088-1 - Thermal conductivity	EN 12664 or EN 12667	specification	1 of each component	1 per year
<sup>1)</sup> According to the specification and workshop drawing of the load bearing thermal insulating element <sup>2)</sup> Except tasks listed in table row 5					

## 4 REFERENCE DOCUMENTS

As far as no edition date is given in the list of standards thereafter, the standard in its current version at the time of issuing the European Technical Assessment is of relevance.

- [1] CEN/TR 15177, Testing the freeze-thaw resistance of concrete - Internal structural damage
- [2] DIN 50106, Testing of metallic materials; compression test
- [3] EN 196-1, Methods of testing cement - Part 1: Determination of strength
- [4] EN 206, Concrete – Specification, performance, production and conformity
- [5] EN 1365-2, Fire resistance tests for loadbearing elements - Part 2: Floors and roofs
- [6] EN 1365-5, Fire resistance tests for loadbearing elements - Part 5: Balconies and walkways
- [7] EN 1990, Eurocode - Basis of structural design
- [8] EN 1992-1-1, Eurocode 2: Design of concrete structures – Part 1-1: General rules and rules for buildings
- [9] EN 1992-1-2, Eurocode 2: Design of concrete structures – Part 1-2: General rules – Structural fire design
- [10] EN 1993-1-1, Eurocode 3: Design of steel structures – Part 1-1: General rules and rules for buildings
- [11] EN 1993-1-4, Eurocode 3 - Design of steel structures - Part 1-4: General rules - Supplementary rules for stainless steels
- [12] EN 10025-1, Hot rolled products of structural steels - Part 1: General technical delivery conditions
- [13] EN 10025-2, Hot rolled products of structural steels - Part 2: Technical delivery conditions for non-alloy structural steels
- [14] EN 10088-1, Stainless steels - Part 1: List of stainless steels
- [15] EN 10204, Metallic products - Types of inspection documents
- [16] EN 10217-7, Welded steel tubes for pressure purposes - Technical delivery conditions - Part 7: Stainless steel tubes
- [17] EN 12390-1, Testing hardened concrete - Part 1: Shape, dimensions and other requirements for specimens and moulds
- [18] EN 12390-3, Testing hardened concrete - Part 3: Compressive strength of test specimens
- [19] EN 12390-5, Testing hardened concrete - Part 5: Flexural strength of test specimens
- [20] EN 12390-6, Testing hardened concrete - Part 6: Tensile splitting strength of test specimens
- [21] EN 12664, Thermal performance of building materials and products - Determination of thermal resistance by means of guarded hot plate and heat flow meter methods - Dry and moist products of medium and low thermal resistance
- [22] EN 12667, Thermal performance of building materials and products – Determination of thermal resistance by means of guarded hot plate and heat flow meter methods – Products of high and medium thermal resistance
- [23] EN 13162, Thermal insulation products for buildings - Factory made mineral wool (MW) products - Specification
- [24] EN 13163, Thermal insulation products for buildings - Factory made products of expanded polystyrene (EPS) – Specification
- [25] EN 13166, Thermal insulation products for buildings - Factory made products of phenolic foam (PF) – Specification
- [26] EN 13501-1, Fire classification of construction products and building elements - Part 1: Classification using data from reaction to fire tests

- [27] EN 13501-2, Fire classification of construction products and building elements - Part 2: Classification using data from fire resistance tests, excluding ventilation services
- [28] EN 15183, Products and systems for the protection and repair of concrete structures – Test methods – Corrosion protection test
- [29] EN ISO 717-2, Acoustics - Rating of sound insulation in buildings and of building elements - Part 2: Impact sound insulation
- [30] EN ISO 1127, Stainless steel tubes - Dimensions, tolerances and conventional masses per unit length
- [31] EN ISO 6892-1, Metallic materials - Tensile testing - Part 1: Method of test at room temperature
- [32] EN ISO 6946, Building components and building elements - Thermal resistance and thermal transmittance - Calculation method
- [33] EN ISO 10140-3, Acoustics - Laboratory measurement of sound insulation of building elements – Part 3: Measurement of impact sound insulation
- [34] EN ISO 10140-5, Acoustics - Laboratory measurement of sound insulation of building elements - Part 5: Requirements for test facilities and equipment
- [35] EN ISO 10211, Thermal bridges in building construction - Heat flows and surface temperatures - Detailed calculations
- [36] EN ISO 10456, Building materials and products - Hygrothermal properties - Tabulated design values and procedures for determining declared and design thermal values
- [37] EN ISO 10848-1, Acoustics – Laboratory measurement of the flanking transmission of airborne and impact sound between adjoining rooms - Part 1: Frame document
- [38] EN ISO 15630-1, Steel for the reinforcement and prestressing of concrete - Test methods – Part 1: Reinforcing bars, wire rod and wire
- [39] EN ISO 16283-2, Acoustics – Field measurement of sound insulation in buildings and of building elements - Part 2: Impact sound insulation
- [40] EN ISO 17660-1:2006, Welding - Welding of reinforcing steel - Part 1: Load-bearing welded joints
- [41] Commission Decision 97/597/EC of 14 July 1997 on the procedure for attesting the conformity of construction products pursuant to Article 20 (2) of Council Directive 89/106/EEC as regards reinforcing and prestressing steel for concrete, OJ L 240, 2.9.1997

## ANNEX A TESTING REQUIREMENTS

### A.1 Load bearing capacity

#### A.1.1 Specimen

The specimens to be tested should take into account the following conditions:

- requirements according to Clause 1.1.2
- maximum load per meter is tested
- width of the specimen is at least one meter
- minimum slab thickness, i.e. in general of 160 mm, test results can be applied to larger slab thicknesses with  $h \leq 500$  mm
- maximum thickness of the thermal insulation material, test results can be applied to smaller joint thicknesses
- biggest nominal diameter for tension and shear force reinforcement, test results can be applied to smaller nominal diameters
- minimum value of edge distance of the compression bearings to the surface of the slab
- at least one specimen with minimum axial edge distance of compression bearings
- concrete strength has to cover the designated concrete strength class with a tolerance of  $\pm 5$  N/mm<sup>2</sup>.

With

$$f_{ck,cyl} = 0,8 \cdot f_{ck,cube150} \quad \text{and} \quad (A.1)$$

$$f_{cm,cyl} = f_{ck,cyl} + 4 \quad \text{results:} \quad (A.2)$$

$$f_{cm,cube} = f_{ck,cube} + 5 \quad \text{and as a result} \quad (A.3)$$

for C 20/25 in the test a tolerance of  $25 \text{ MPa} \leq f_{cm,cube} \leq 35 \text{ MPa}$ , results may be interpolated between two concrete strength classes

- age of the test slabs at least 7 days
- concrete composition of the slabs with the following requirements:
  - concrete aggregate: round grain, grading curve AB
  - cement CEM I/A 32.5 or 42.5, CEM II/A 32.5 or 42.5, CEM III/A 32.5 or 42.5, category N or R
  - maximum aggregate size not exceed 16 mm
- anchorage and lap splices of the bars are determined according to EN 1992-1-1 or specifically assessed according to Table 2.1
- When dimensioning the tensile reinforcement in the tests with failure of concrete edge or concrete compression bearing shall be investigated to what extent the use of the tension zone has an influence on the fracture behavior of the concrete. In general, the tensile stress of steel should be between design resistance and characteristic value of the yield strength in these tests.

In order to determine the material properties of the specimens, tests according to Table A.1 have to be performed.

The tensile strength of the concrete slabs shall be determined and compared with the measured values of the concrete compressive strength. If the measured tensile strengths are greater than the calculated, more detailed studies are required.

**Table A.1:** Evaluation of material properties

No	Item	Specimen	Number	Testing procedure
1	Compressive strength of the concrete of the slab at time of testing	Cube 150 mm or cylinder 150/300 mm	3	EN 12390-3
2	Flexural strength or Tensile splitting strength of the concrete of the slab at time of testing	Prism 150/150/700 mm or Cylinder 150/300 mm	3	EN 12390-5 or EN 12390-6
3	Compressive strength of concrete bearing at time of testing <sup>3)</sup>	Concrete bearing, length ~ thickness of thermal insulation material <sup>2)</sup> or Prism 160/40/40 mm	10 <sup>1)</sup>	EN 12390-3 EN 196-1
4	Strength characteristics of common reinforcing steel	Steel bar	3	EN ISO 6892-1
5	Strength characteristics of stainless steel	Steel bar	3	EN ISO 6892-1
6a	Strength characteristics of welded bar combination	Welded reinforcing and stainless steel with same diameter	3	EN ISO 17660-1
6b	Strength characteristics of welded bar combination	Welded reinforcing and stainless steel with different diameters and different yield strengths	5 per diameter combination	EN ISO 6892-1 EN ISO 17660-1

<sup>1)</sup> A smaller number is also acceptable for a small scatter of the test results

<sup>2)</sup> For concrete compression bearings and concrete compression shear bearings with shapes different to prismatic or cylindrical shapes - determination of the load bearing capacity of the bearing in direct compression test with adapted loading platens

<sup>3)</sup> Declaration of the characteristic maximum force and the characteristic compressive and flexural strength of the concrete compression bearing and the concrete compression shear bearing as a 5 % fractile at a probability of 0.90 (one-sided)

### A.1.2 Test rig

To consider indirect load transmission, the support of the supported slab shall have a distance ( $L_3$  according to Figure A.1 to A.4) to the edge of the thermal insulation material of at least the thickness of the slab.

The force is applied by a line load. For shear tests the load shall have distance of at least twice the thickness of the slab from the edge of the thermal insulation material.

The load application shall be carried out with a possible horizontal displacement of the slab.

During the test the following measurements and observations shall be performed, recorded and documented by photos.

- The loads applied,
- The force in the support of the external slab in shear tests,
- The absolute displacement at the end of the slab,
- The relative displacement across the joint,
- The relative horizontal displacement across the joint in cyclic displacement tests,
- Optionally strain of the tension bars,

- Optionally strain of the shear bars,
- Formation of cracks and crack widths for any load level,
- The failure mode.

However, displacement transducer may be removed before failure not to endanger the integrity of the transducers due to failure of the specimen.

The test rig with installed specimen is shown in Figure A.1 and Figure A.2 for bending tests and in Figure A.3 and Figure A.4 for shear tests.

### A.1.3 Test procedure

The expected load bearing capacity shall be calculated and be applied displacement controlled in at least 5 preferably equal load steps. Each single load step has to be maintained for 5 minutes. After attaining the last load step, the load has to be increased until failure of the specimen.

Alternatively the expected load bearing capacity and the serviceability load shall be calculated. The load is applied displacement controlled. Every load step has to be maintained for at least 3 minutes, this is followed by an unloading to approximately 1 to 5 kN/m at least 1 minute. Firstly the serviceability load is applied 10 times, thereafter the calculated design capacity is applied 3 times. Finally the load is increased until failure of the specimen.

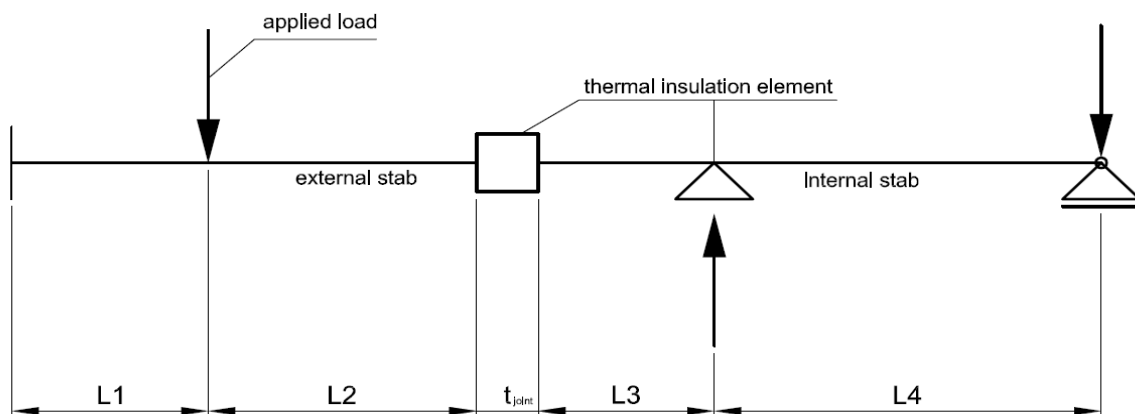

**Figure A.1:** Model for bending testing

Top view

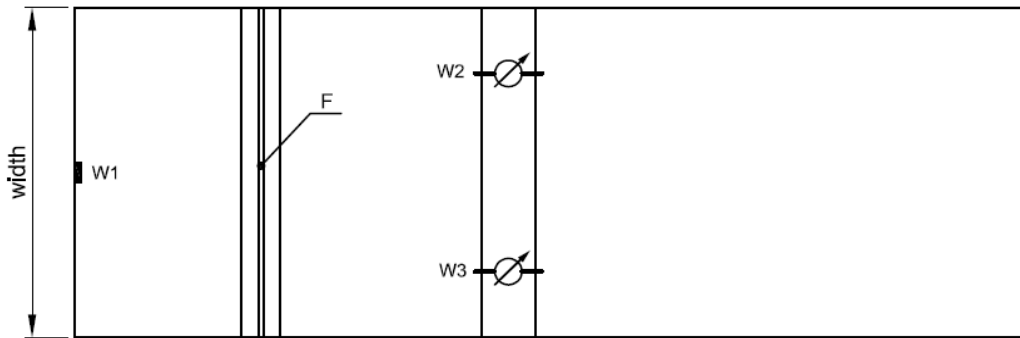

Elevation

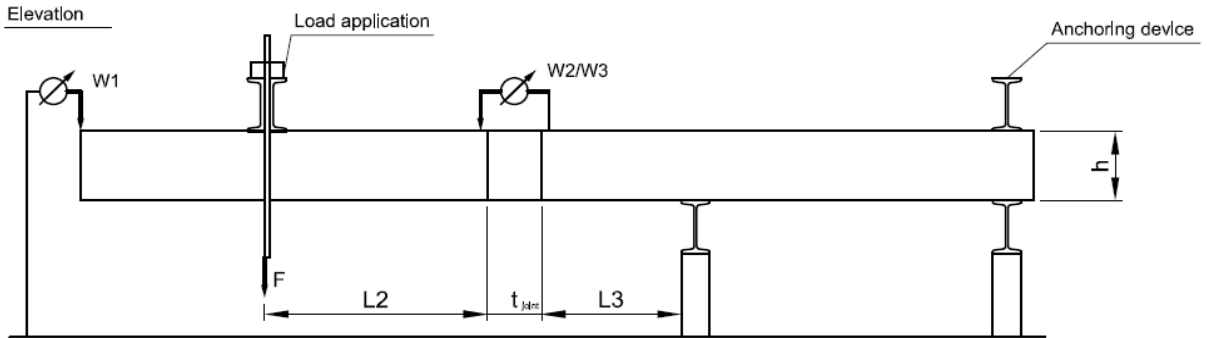

Figure A.2: Test rig for bending test

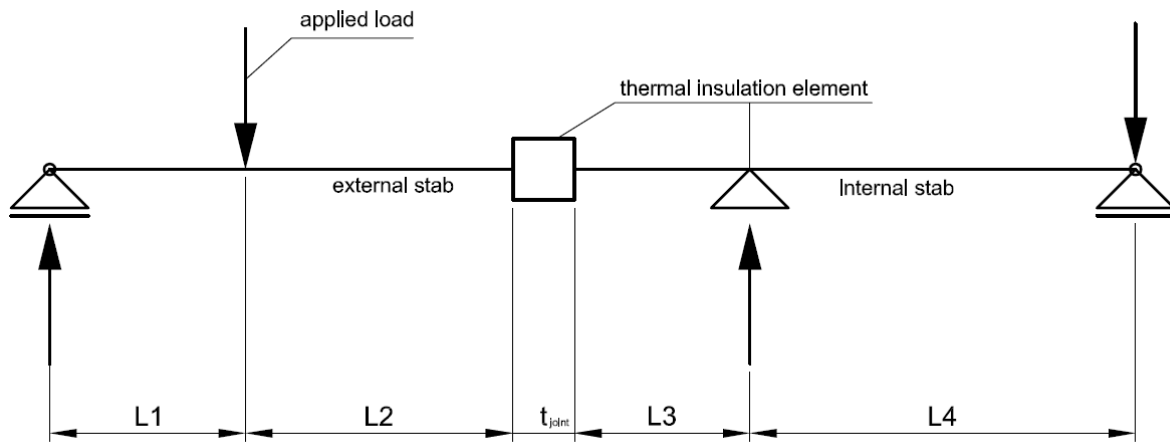
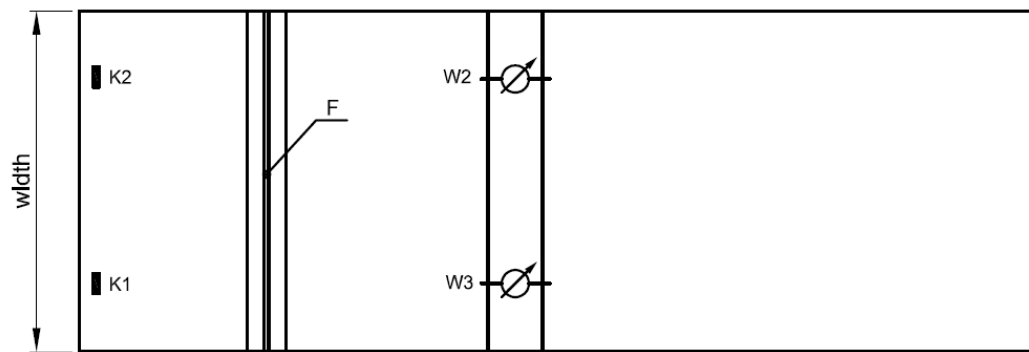
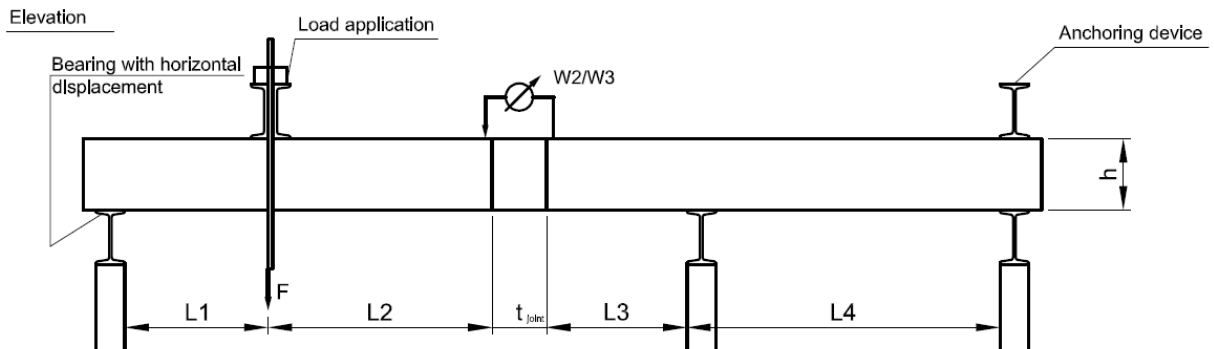

Figure A.3: Model for shear testing

Top view



Elevation



**Figure A.4:** Test rig for shear test

## A.2 Thermal actions

### A.2.1 Specimen

The element with the highest load bearing capacity, the largest diameter of the reinforcing bar in the joint and the minimum thickness of the thermal insulation material has to be tested. Otherwise the provisions of Clause A.1.1 shall apply for the specimen.

### A.2.2 Test rig

The same test rig as for the bending test of Clause A.1.2 shall be used. In addition lateral load is applied to the cantilever slab with a distance of about 10 cm to the edge of the thermal insulation material, see Figure A.5. The lateral load shall induce a defined cyclic displacement between the two slabs. During the cyclic displacement a constant vertical load has to be applied to the cantilever slab.



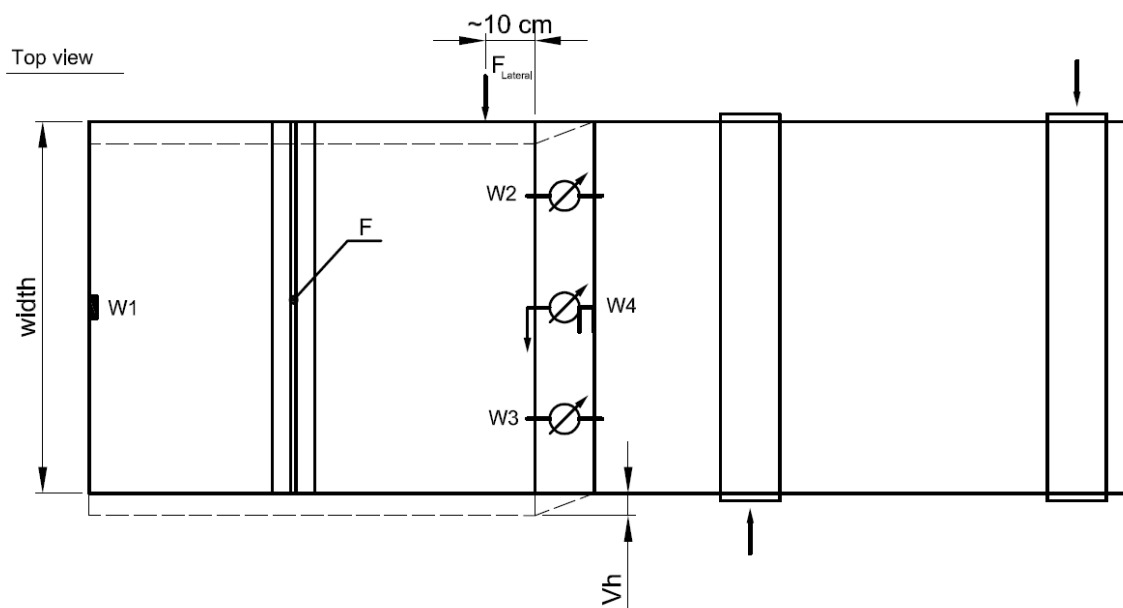

**Figure A.5:** Test rig for cyclic lateral displacement test

**A.2.3 Test procedure**

The expected load bearing capacity and the serviceability load, about 50 % of the capacity, shall be calculated. The serviceability load is applied and maintained constant throughout the cyclic lateral test.

The horizontal load is applied as a sinusoidal stress. The frequency in the test shall be between 0,1 and 1 Hz. In a test period of several days the concrete strength of the last day of the test is relevant for assessing the failure load.

**A.2.4 Application of cyclic lateral displacements**

To determine the displacement a slab with defined width,  $s_{joint}$  is assumed, according to specification of the manufacturer, stated in the ETA (see Figure A.6). The slab is subjected to a lateral cyclic displacement corresponding to the temperature spectrum of Table A.2. The displacements resulting from these temperatures are calculated to:

$$v_h = \pm \frac{s_{joint} \cdot \alpha_c \cdot \Delta T}{4} \tag{A.4}$$

NOTE: The width of the slab,  $s_{joint}$ , does not need to correspond to the width of the specimen for the cyclic lateral displacement test.

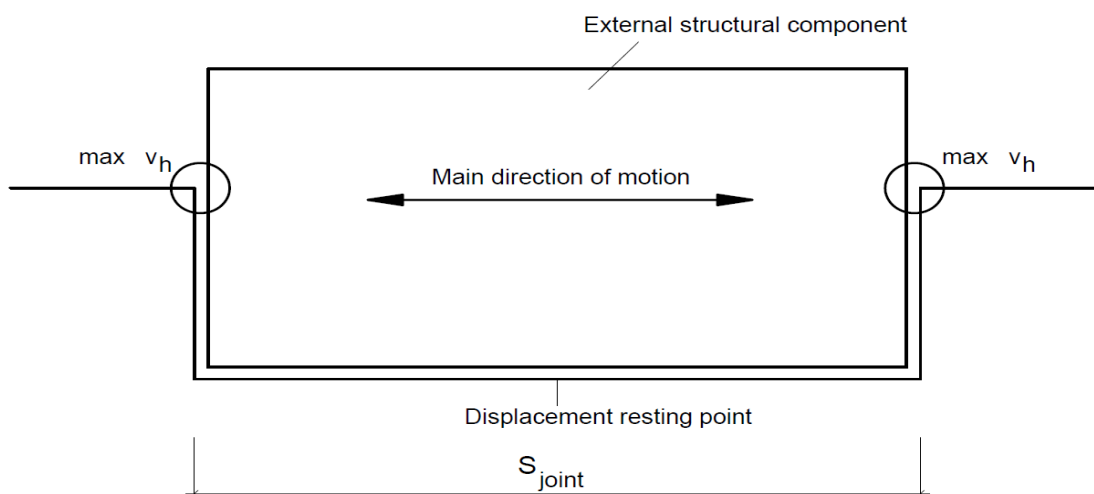

**Figure A.6:** Installation situation with support on opposite edges

**Table A.2:** Temperature spectrum for cyclic displacement test

No	Number of displacement cycles	Total temperature difference
1	1 000 displacement cycles corresponding to	$\Delta T = 40 \text{ K}$
2	100 displacement cycles corresponding to	$\Delta T = 70 \text{ K}$
3	2 000 displacement cycles corresponding to	$\Delta T = 60 \text{ K}$
4	19 000 displacement cycles corresponding to	$\Delta T = 40 \text{ K}$

After the cyclic displacement test the concrete compression bearings or concrete compression shear bearings and the adjacent concrete shall be free of spalling. The cracks in the concrete compression bearings or concrete compression shear bearings and the adjacent concrete shall be assessed in accordance with EN 1992-1-1, Table 7.1N.

The cyclic displacement test shall not adversely affect the load bearing capacity of the product to a considerable extent.

After the lateral displacement cycles have been completed, the specimen shall be unloaded with regard to the vertical and lateral load. Subsequently the vertical load is increased until failure of the specimen.

If the test result is considered in the statistical evaluation according to Clause B.2.2.2 and B.2.2.3, the test until failure shall be performed as given in Clause A.1.3.

After the cyclic displacement test and subsequent static test at least 95 % of the static resistance (based on the characteristic value) of the element without cyclic loading shall be reached.

The distance of expansion joints in the cantilever slab,  $s_{\text{joint}}$ , results from the width of the slab for calculating the temperature displacements.

## ANNEX B STRUCTURAL MODELS AND CALCULATION METHODS

### B.1 Structural models

The structural models given in the Clauses below are examples. Adapted strut-and-tie models following the same principles, e.g. for slabs with height offset between external and internal part, are as well applicable.

Also included are concrete bearings with capacities to transfer compression forces only and concrete compression shear bearings with capacities to transfer compression and shear forces.

#### B.1.1 Structural model with shear bars

The structural model to be applied for the product is a strut-and-tie model. According to the forces and moments to be transferred by the product, bending and shear or shear only, two typical models are shown in Figure B.1 and Figure B.2.

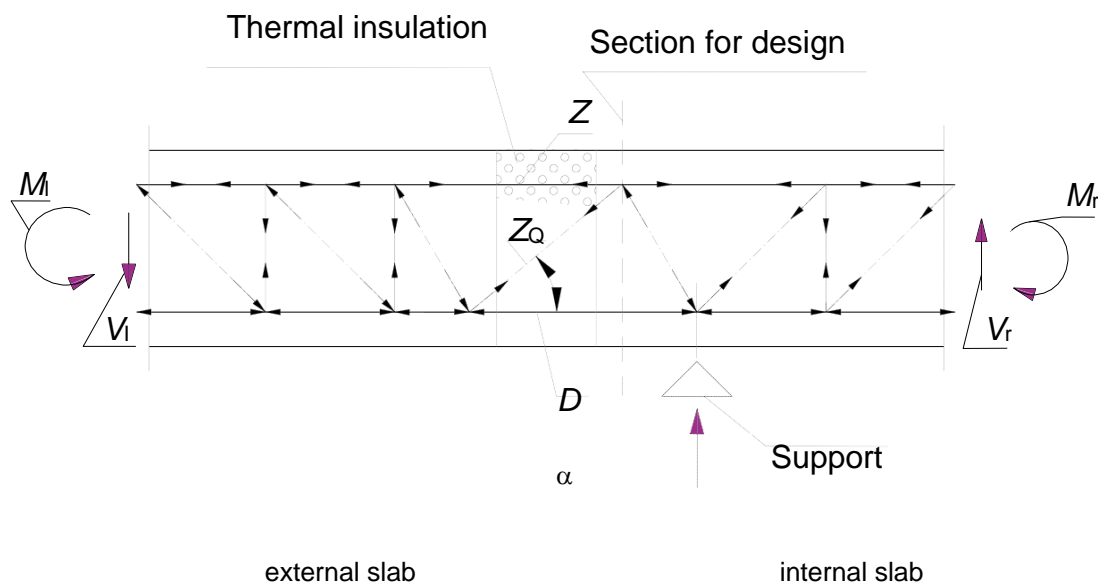

Figure B.1: Strut-and-tie model to transfer bending and shear force – Schematic example

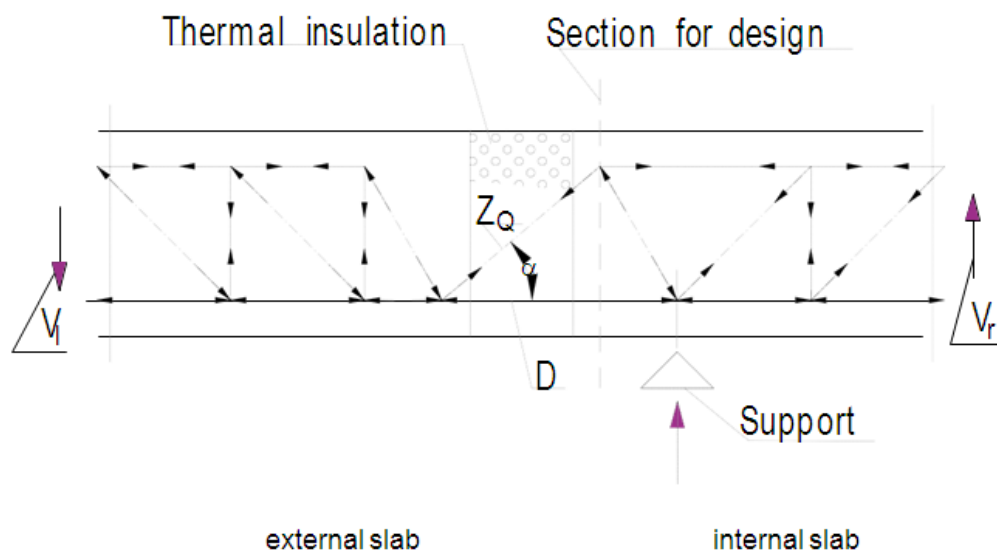
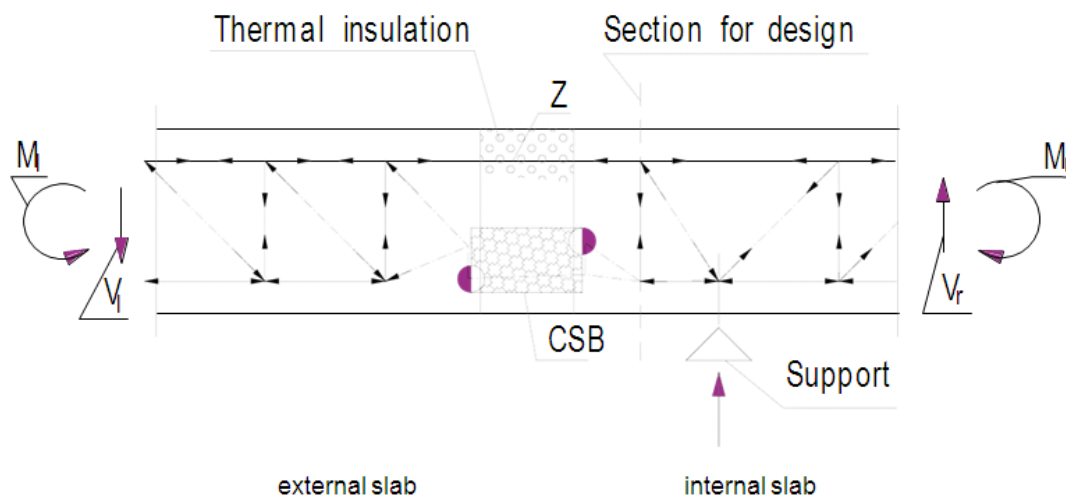

Figure B.2: Strut-and-tie model to transfer shear force only – Schematic example

### B.1.2 Structural model with concrete compression shear bearing

The structural model to be applied for the product is a strut-and-tie model with concrete compression shear bearing (CSB). The concrete compression shear bearing transfers compression and shear forces. According to the forces and moments to be transferred by the product, bending and shear or shear only, two typical models are shown in Figure B.3 and Figure B.4.



**Figure B.3:** Strut-and-tie model with concrete compression shear bearing (CSB) to transfer bending and shear force – Schematic example

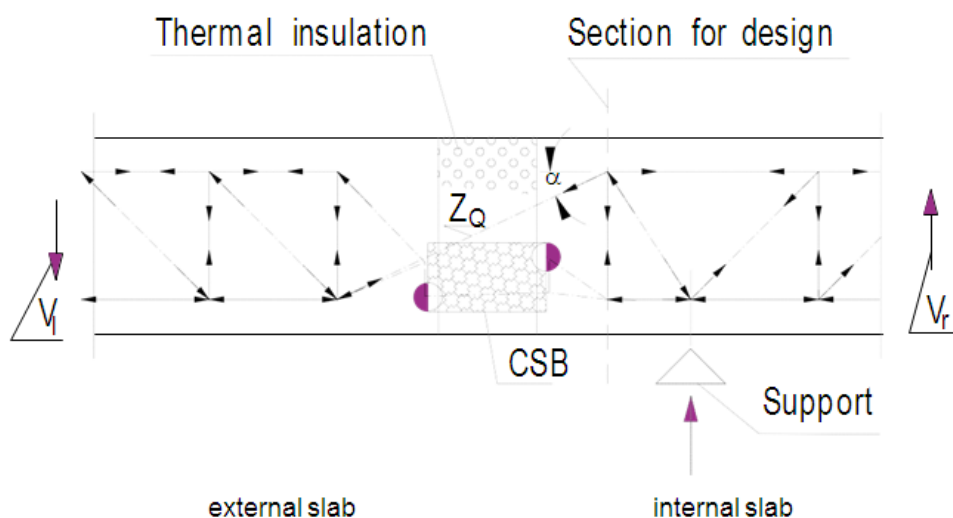

**Figure B.4:** Strut-and-tie model with concrete compression shear bearing (CSB) and shear reinforcement to transfer shear force only – Schematic example

## B.2 Calculation methods

### B.2.1 General

A design concept considering all failure modes, see Table 2.1, shall be established. This design concept shall be applied to the results of the tests performed as follows.

The design for the external and internal slabs shall be carried out according to EN 1992-1-1. The load introduction of the shear forces into the concrete of the external and internal slabs shall be verified.

## B.2.2 Load bearing capacity

Load bearing capacity shall be calculated according to EN 1992-1-1 and EN 1993-1-1. Variable moments and shear forces along a connected edge shall be considered. Strain on the slab connections due to local torsion moments shall be excluded.

### B.2.2.1 Load bearing capacity of the steel compression bearing

#### B.2.2.1.1 General

One of the following methods can be used for the determination of the buckling load of steel compression bearing.

#### B.2.2.1.2 Calculation method for buckling of steel compression bearing

For compression bearings made of stainless steel bars buckling is calculated according to EN 1993-1-1, Clause 6.3.1 and the following:

$$\bar{\lambda} \leq 0,13 \quad \chi = 1 \quad (B.1)$$

$$\bar{\lambda} > 0,13 \quad \chi \text{ according to equation EN 1993-1-1, equation (6.49)} \quad (B.2)$$

Where:

$$\Phi = 0,5 [1 + \alpha \cdot (\bar{\lambda} - 0,13) + \bar{\lambda}^2] \quad (B.3)$$

with:

$$\alpha = 0,92 \quad (B.4)$$

- Only solid steel bars with practically circular cross section area are subject to calculation.
- The buckling shape shall take into account a depth of  $1 \cdot \phi$  in the concrete.
- Normally a compression bar fixed on both ends is assumed.
- The mechanical properties of the steel bar are to be taken as S355.

Otherwise the load bearing capacity of the compression element has to be determined by tests and by derivation of a numerical method as follows.

#### B.2.2.1.3 Buckling test of steel compression bearing

The length of the specimen shall result in a free length of at least  $2 \cdot \phi$  + maximum thickness of the thermal insulation material. The total length of the specimen shall consider the device to hold in place the specimen in the testing machine. The end planes of the specimen shall be flat and square cut.

The specimen shall be placed in a testing machine with a device capable to efficiently hold it in place throughout the test.

Loading shall be by the head of the testing machine, travelling at a constant speed. Maximum load shall be attained not before 1 minute after the test has started.

5 specimens per size of the compression element shall be tested.

The characteristic value as a 5 % fractile according to EN 1990 of the maximum force shall be stated in the ETA.

Tests to determination of the buckling load in the factory production control according to Table 4 are not necessary if a reduction factor derived for the ratio of  $R_{p,c0,2,act} / R_{p,t0,2,act}$  as follows:

- 5 tensile tests per material grade and per diameter according to EN ISO 6892-1 for determination of  $R_{p,t0,2,act}$
- 5 compression tests per material grade and per diameter according to DIN 50106 for determination of  $R_{p,c0,2,act}$
- determination of the ratio of  $R_{p,c0,2,act} / R_{p,t0,2,act}$  per material grade of all diameters and all system lengths, the minimum ratio is on the save side deciding for the reduction factor for the determination of  $f_y$  according to EN 1993-1-1, Clause 6.3.1.2(1)

#### B.2.2.1.4 Numerical method for determination of buckling load of steel compression bearing

If the buckling load of compression elements is determined by using numerical methods (e.g. finite element method), a benchmark to proof the accuracy of the numerical model has to be carried out as follows:

- experimental tests at least on the smallest and biggest nominal diameter, minimum five tests per diameter, per material grade and per system length (depending on the thickness of the thermal insulation element)
- comparison of numerical and experimental results, the characteristic value of the buckling load determined by numerical method shall be less than the 5%-fractile value of the experimental buckling load (for each diameter, system length and material grade)

$$N_{Kical} \leq N_{KiTest5\%} \quad (B.5)$$

and

the ratio of calculated and experimental buckling load is a constant value for all diameters and system lengths per one material grade

$$\left( \frac{N_{Kical}}{N_{KiTest5\%}} \right)_{min} \geq 0,9 \cdot \left( \frac{N_{Kical}}{N_{KiTest5\%}} \right)_{max} \quad (B.6)$$

#### B.2.2.2 Load bearing capacity of the load bearing thermal insulating element

The load bearing capacities are calculated according to the design concept with the mean values of the strength of the materials. I.e. mean concrete compressive strength, mean yield strength, etc. The calculated capacities of the slab,  $M_t$  and  $V_t$ , are related to the test results,  $M_u$  and  $V_u$ , by

$$\frac{M_u}{M_t} \text{ and } \frac{V_u}{V_t} \quad (B.7)$$

The mean values  $\xi_{M,m}$  and  $\xi_{V,m}$  and the fractile values  $\xi_{M,5\%}$  and  $\xi_{V,5\%}$  according to Equation (B.12) shall be employed to validate the design model.

All tests with the same failure mode are evaluated together by calculating the mean value, the coefficient of variation and the 5%-fractile.

For the evaluation of the tests with concrete edge failure a standardization of the test values is carried out at the ratio of the mean value of the calculated concrete tensile strength to the actual tensile strength of concrete. The mean value of the calculated concrete tensile strength is the basis for the evaluation with:

$$f_{ctm} = (f_{ck,cyl})^{\frac{2}{3}} \quad (B.8)$$

If the calculation of the bearing capacity of the concrete edge according to the design model is not linearly (with exponent) dependent on the compressive strength of concrete, a conversion of the compressive strength in the tensile strength of the standardization of the test values is not required.

$$\xi_{M,m} = \frac{1}{n} \cdot \sum_{i=1}^n \left( \frac{M_u}{M_t} \right)_i \quad \text{and} \quad \xi_{V,m} = \frac{1}{n} \cdot \sum_{i=1}^n \left( \frac{V_u}{V_t} \right)_i \quad \text{mean value} \quad (B.9)$$

$$v_M = \frac{1}{\xi_{M,m}} \cdot \sqrt{\frac{1}{n-1} \sum_{i=1}^n \left( \left( \frac{M_u}{M_t} \right)_i - \xi_{M,m} \right)^2} \cdot 100 \quad \text{coefficient of variation} \quad (B.10)$$

$$v_V = \frac{1}{\xi_{V,m}} \cdot \sqrt{\frac{1}{n-1} \sum_{i=1}^n \left( \left( \frac{V_u}{V_t} \right)_i - \xi_{V,m} \right)^2} \cdot 100 \quad \text{coefficient of variation} \quad (\text{B.11})$$

$$\xi_{M,5\%} = \xi_{M,m} \cdot \left( 1 - k_n \cdot \frac{v_m}{100} \right) \quad \text{and} \quad \xi_{V,5\%} = \xi_{V,m} \cdot \left( 1 - k_n \cdot \frac{v_m}{100} \right) \quad \text{5\%-fractile} \quad (\text{B.12})$$

Where

$\xi_{M,m}$  mean value of relative moments

$\xi_{V,m}$  mean value of relative shear force

$\xi_{M,5\%}$  5%-fractile of relative moments

$\xi_{V,5\%}$  5%-fractile of relative shear force

$v_M, v_M$  coefficient of variation of relative moments and shear forces

$\left( \frac{M_u}{M_t} \right)_i$  relative moment of test i (B.13)

$\left( \frac{V_u}{V_t} \right)_i$  relative shear force of test i (B.14)

$k_n$  factors according to EN 1990, Table D.1, for an unknown coefficient of variation

For assessment of concrete edge failure the coefficient of variation shall be taken according to Table B.1.

**Table B.1:** Concrete edge failure – Coefficient of variation

No	Subject	Coefficient of variation v
1	For number of tests < 10	$\geq \max \left\{ \begin{array}{l} v \text{ according to evaluation of test results} \\ 10 \% \end{array} \right.$
2	For number of tests $\geq 10$	$\geq (v \text{ according to evaluation of test results})$

### B.2.2.3 Load bearing capacity of the load bearing thermal insulating element (stated in the ETA)

The load bearing capacities are calculated according to the design concept with the design values of the strength of the materials.

$$f_{cd} = (f_{cm} - 4) \cdot \frac{\alpha_{cc}}{1,5} \quad \text{design concrete compressive strength of the slab} \quad (\text{B.15})$$

$$f_{yd} = \frac{f_{yk}}{1,15} \quad \text{design yield strength of reinforcing steel with } f_{y,k} \leq 700 \text{ MPa} \quad (\text{B.16})$$

$$f_{yd} = \frac{f_{yk}}{1,21} \quad \text{design yield strength of reinforcing steel with } 700 \text{ MPa} < f_{y,k} \leq 900 \text{ MPa} \quad (\text{B.17})$$

$$f_{yd} = \frac{f_{yk}}{1,1} \quad \text{design yield strength of plain stainless steel} \quad (\text{B.18})$$

$$f_{cd,CB} = f_{ck,CB} \cdot \frac{\alpha_{cc}}{1,5} \quad \text{design compressive strength of compression bearing} \quad (\text{B.19})$$

Where

$f_{cm}$  mean concrete compressive strength of the slab

$f_{yk}$  characteristic yield strength of reinforcing steel

$f_{ck,CB}$  characteristic concrete compressive strength of the concrete compression bearing

$\alpha_{cc}$  coefficient taking account of long term effects on the compressive strength, according to Table B.2

The coefficient  $\alpha_{cc}$  shall be 0,80 (brittle failure according to Table B.2), if no tests are performed to notice behavior of concrete edge failure and failure of compression bearing.

**Table B.2:**  $\alpha_{cc}$

No	Subject	$\alpha_{cc}$
1	Concrete edge ductile failure brittle failure	1,00 0,80
2	Concrete compression bearing ductile failure brittle failure	1,00 0,80

In order to classify the concrete edge failure and/or the failure of compression bearing as a ductile failure the following tests are required.

Tests according to A.1.3 are carried out achieving concrete failure mode of concrete edge or concrete compression bearing or concrete compression shear bearing respectively. After the maximum load is achieved, specimen is unloaded to approximately 1 to 5 kN/m for at least 1 minute. Ductile behavior is verified if the calculated design capacity can be applied 3 times without significant increase of damage. At least 3 tests per failure mode are required.

The load bearing capacities are calculated according to the design concept with the design values of the strength of the materials. The calculated capacities of the slab,  $M_{td}$  and  $V_{td}$ , are related to the test results,  $M_u$  and  $V_u$ , by

$$\frac{M_u}{M_{td}} \quad \text{and} \quad \frac{V_u}{V_{td}} \quad (\text{B.20})$$

All tests with the same failure mode are evaluated together by calculating the mean value, the coefficient of variation and the 5%-fractile.

$$\xi_{M,d} = \frac{1}{n} \sum_{i=1}^n \left( \frac{M_u}{M_{td}} \right)_i \quad \text{and} \quad \xi_{V,d} = \frac{1}{n} \sum_{i=1}^n \left( \frac{V_u}{V_{td}} \right)_i \quad \text{mean value} \quad (\text{B.21})$$

$$V_{Md} = \frac{1}{\xi_{M,d}} \cdot \sqrt{\frac{1}{n-1} \sum_{i=1}^n \left( \left( \frac{M_u}{M_{td}} \right)_i - \xi_{M,d} \right)^2} \cdot 100 \quad \text{coefficient of variation} \quad (\text{B.22})$$



$$V_{Vd} = \frac{1}{\xi_{V,d}} \cdot \sqrt{\frac{1}{n-1} \sum_{i=1}^n \left( \left( \frac{V_u}{V_{td}} \right)_i - \xi_{V,d} \right)^2} \cdot 100 \quad \text{coefficient of variation} \quad (\text{B.23})$$

$$\xi_{Md,5\%} = \xi_{M,d} \cdot \left( 1 - k_n \cdot \frac{V_{Md}}{100} \right) \quad \text{and} \quad \xi_{Vd,5\%} = \xi_{V,d} \cdot \left( 1 - k_n \cdot \frac{V_{Vd}}{100} \right) \quad \text{5\%-fractile} \quad (\text{B.24})$$

Where

$\xi_{M,d}$  mean value of relative moments, determined with the design strength of the materials

$\xi_{V,d}$  mean value of relative shear force, determined with the design strength of the materials

$\xi_{Md,5\%}$  5%-fractile of relative moments, determined with the design strength of the materials

$\xi_{Vd,5\%}$  5%-fractile of relative shear force, determined with the design strength of the materials

$V_{Vd}, V_{Md}$  coefficient of variation of relative moments and shear forces, determined with the design strength of the materials

$$\left( \frac{M_u}{M_{td}} \right)_i \text{ relative moment of test } i \quad (\text{B.25})$$

$$\left( \frac{V_u}{V_{td}} \right)_i \text{ relative shear force of test } i \quad (\text{B.26})$$

$k_n$  factors according to EN 1990, Table D.1, for an unknown coefficient of variation

For assessment of concrete edge failure the coefficient of variation shall be taken according to Table B.1.

For assessment of failure of the compression bearings or compression shear bearings the coefficient of variation shall be taken from the mean variation of the laboratory tests and an unknown population standard deviation. If there are long-term experiences with the capacity and their variations of compression bearings or compression shear bearings (minimum number of test results is 100), a known population standard deviation can be recognized. The minimum value for the coefficient of variation of 6 % shall be complied.

$\xi_{Md,5\%}$  and  $\xi_{Vd,5\%}$  have to be larger than the corresponding material factors given in Equations (B.15) to (B.19). The large scale tests shall confirm the applied lattice model for the product together with the edge distances.

### B.2.3 Stiffness and deformation

The rotation of the balcony slab can be determined from the elastic strain of the tension bar  $\Delta l_t$  and the elastic compression strain of the compression bearing and the adjacent materials in the force transfer area of the compression bearing  $\Delta l_d$  with:

Angle of rotation in the joint:

$$\tan \alpha_{\text{joint}} = \frac{\Delta l_t - \Delta l_d}{z_1} \tag{B.27}$$

Tension bar:

$$\begin{aligned} \Delta l_t &= \varepsilon_{t,ds1} \cdot l_{\text{eff},t,ds1} + \varepsilon_{t,ds2} \cdot l_{\text{eff},t,ds2} \\ &= \frac{\sigma_{s,t,ds1}}{E_{s,ds1}} \cdot l_{\text{eff},t,ds1} + \frac{\sigma_{s,t,ds2}}{E_{s,ds2}} \cdot l_{\text{eff},t,ds2} \end{aligned} \tag{B.28}$$

Compression bearing:

$$\Delta l_{d1} = -\varepsilon_{d1} \cdot l_{\text{eff},d1} = \frac{-\sigma_{c,d1}}{E_c} \cdot l_{\text{eff},d1} \tag{B.29}$$

Compression of the adjacent materials:

$$\Delta l_{d2} = -\varepsilon_{d2} \cdot l_{\text{eff},d2} \tag{B.30}$$

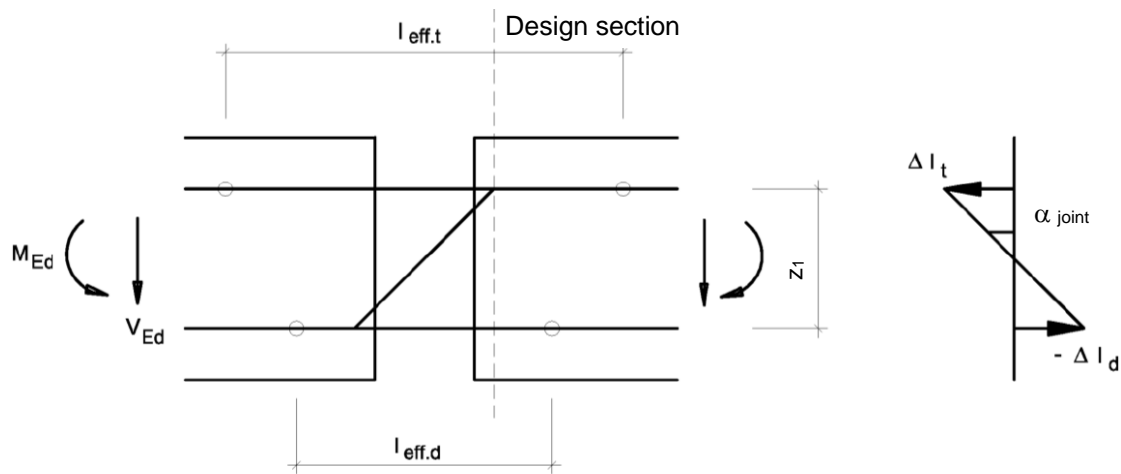

**Figure B.5:** Model for determination of rotation in the insulation joint for elements with steel compression bearings

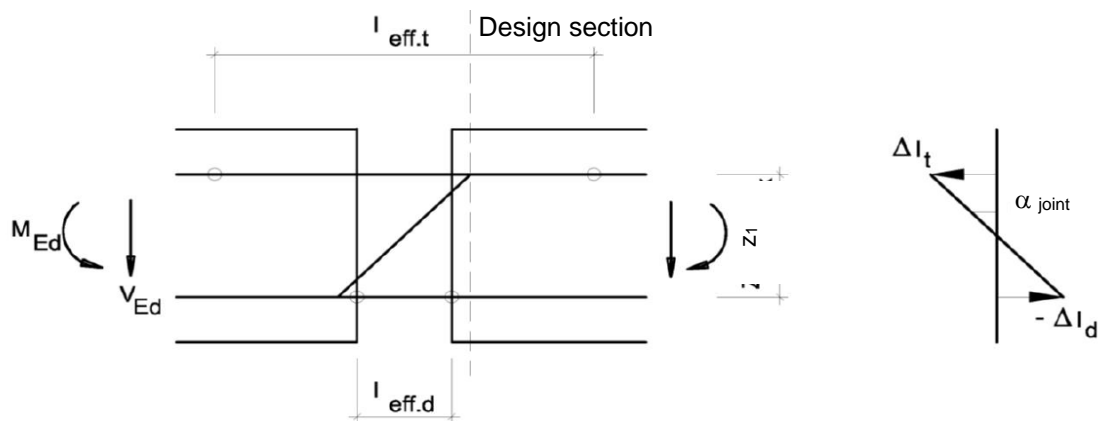

**Figure B.6:** Model for determination of rotation in the insulation joint for elements with concrete compression bearings

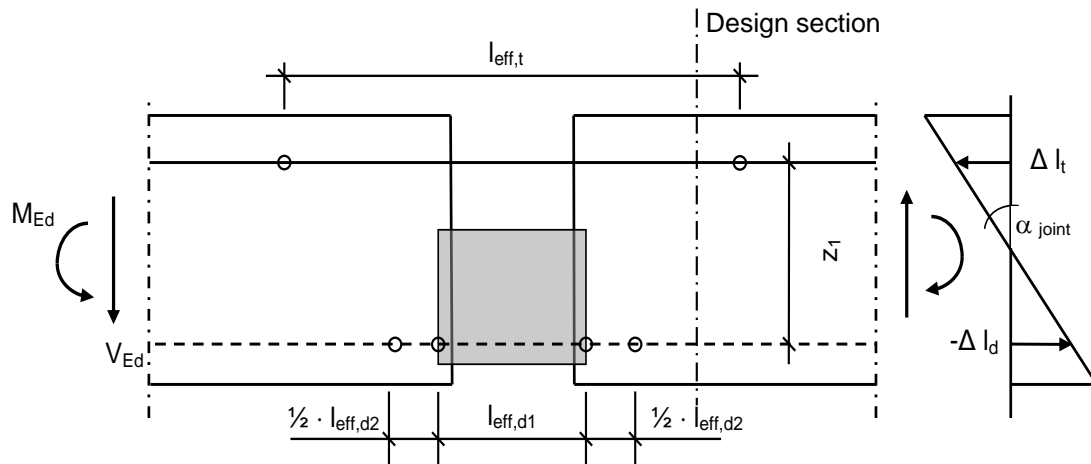

**Figure B.7:** Model for determination of rotation in the insulating joint for elements with concrete compression shear bearings

with:

- $l_{eff,t}$  = effective length of the tension bar
- $l_{eff,d1}$  = effective length of the compression bearing
- $l_{eff,d2}$  = effective length of the slab concrete

The calculation method is to be verified with the test results from Clause 2.2.1.

## ANNEX C FREEZE THAW RESISTANCE

### C.1 General

The following procedure is based on CEN/TR 15177, Section 7, beam test.

### C.2. Principle

Concrete compression bearings are subjected to freeze-thaw attack in presence of deionized water. The freeze-thaw resistance is measured as relative dynamic modulus of elasticity by using ultrasonic pulse transit time after 56 freeze-thaw cycles.

### C.3. Equipment

#### C.3.1 Freezing

Freezing chamber or freeze-thaw chest with cooling liquid or a flooding device

The freezing chamber or the freeze-thaw chest are equipped with a temperature and time controlled refrigerating and heating system with a capacity such that the time-temperature plots in the center of the reference body prescribed in Figure C.1 can be followed. An automatically controllable frost chest and a water tank with thermostatic control can also be used instead of an automatically controlled freeze-thaw chest with flooding device.

#### C.3.2 Temperature measurement

Thermocouples, or an equivalent temperature measuring device, for measuring the temperature at the appropriate prescribed points in the freezing chest with an accuracy within  $\pm 0,5$  K.

#### C.3.3 Balance

Balance with an accuracy within  $\pm 0,05$  g.

#### C.3.4 Vernier callipers

Vernier callipers, with an accuracy within  $\pm 0,1$  mm.

#### C.3.5 Towel

Absorbent laboratory towel.

#### C.3.6 Reference body

Thermometric frost resistance reference body of concrete with the dimensions of the concrete compression bearing

A tolerance in length of  $\leq 10\%$  will be permissible. A thermocouple, Clause C.3.2, is installed near the geometric centre of the thermometric reference body in order to measure the temperature variations during freeze-thaw cycles.

#### C.3.7 Equipment for ultrasonic pulse transit time (UPTT)

The Ultrasonic pulse transit time (UPTT) measurement device is suitable for determining the transit times of longitudinal waves in porous building materials according to EN 12504-4. The transducers operate in frequency range between 50 kHz and 150 kHz.

### C.4. Preparation of test specimens

The test requires at least three specimens of concrete compression bearings.

When the specimens are 7 days old, they are weighed. The mass is rounded to the nearest 0,1 g. The specimens are immersed in a water bath having temperature of  $(20 \pm 2)^\circ\text{C}$ . They are stored for 21 days under water until the start of the freeze-thaw test.

The spots which are used to determine the ultrasonic pulse transit time are marked on the specimen surface in the middle of the fronts. The spots are used for each measuring occasion.

## C.5. Measurement procedure

### C.5.1 Ultrasonic pulse transit time (UPTT)

The prisms are removed from the water bath and the surfaces dried with an absorbent towel. During the period when the samples are out of the water bath and are not being tested they are covered with moist towels. The weight of the specimens is determined with an accuracy of 0,1 g.

The ultrasonic equipment is checked according to the instruction manual.

A little amount of sonic grease is applied to the contact surface of the transducers and the marked points of the specimens. In each case the transducers are arranged on the two opposite marked points of the specimens.

The transducers are pressed against the concrete surfaces so that a constant minimum value is reached. The transmission time is read with an accuracy of 0,1  $\mu$ s. It is required that the transducers are squeezed to the concrete surface with the same pressure for each measuring occasion.

The specimens are returned vertically to the freeze-thaw plant.

The relative dynamic modulus of elasticity  $RDM_{UPTT}$  is calculated in percentage according to following Equation.

$$RDM_{UPTT,n} = \left( \frac{t_{s,0}}{t_{s,n}} \right)^2 \cdot 100 \quad (C.1)$$

## C.6 Test procedure

The freeze-thaw test starts after 28 days. The specimens are removed from the water bath and their surfaces are dried with an absorbent towel. The weight of each specimen is measured and rounded to the nearest 0,1 g.

The initial value for the measurement of the internal structural damage is determined for each specimen according to Clause C.5.1. Immediately after this measurement the specimens are placed vertically in the freeze-thaw chest.

The freeze-thaw cycles begin 2 h at the latest after the concrete prisms are removed from water storage.

The temperature of the freeze-thaw chest is controlled so that the temperature in the center of the concrete prism corresponds substantially to the temperature range in Figure 12. The temperature shall not deviate from the shaded area in the diagram by more than 1 K for any specimen whereas the temperature difference between 2 specimens shall be  $\pm 1$  K. The temperature pattern of each cycle differs from that of the first cycle by less than  $\pm 1$  K. The air temperature in the freeze-thaw chest shall no fall below  $-25$  °C.

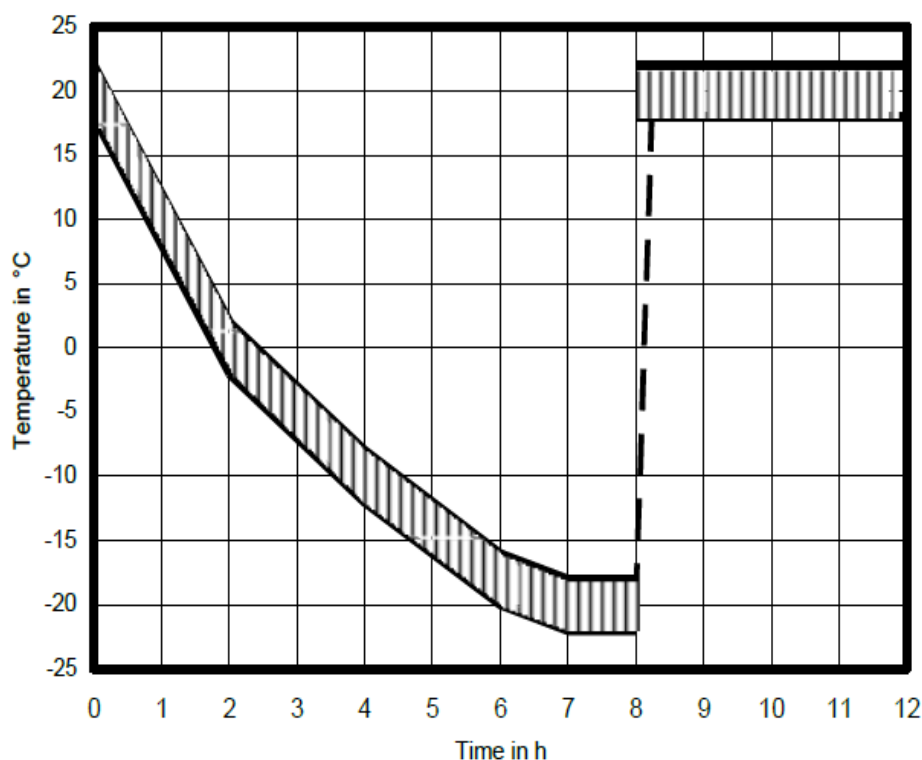

**Figure C.1:** Time temperature plot in the center of the reference body

Once a week the prisms are turned through 180 ° so that the former top surface of the prism is placed on the floor of the chest. The prisms shall also be placed in different positions in the chest in accordance with some appropriate cyclic positioning plan. The distances of the concrete prisms from one another and from the wall are at least 60 mm.

**NOTE** The number of specimens in the freezing chamber or frost chest is always the same. If only few specimens are to be tested, the empty places in the freezer are filled with blanks, unless it has been shown that the correct temperature cycle is achieved without this precaution.

Immediately after the 8 h freezing phase the freeze-thaw chest is flooded with water at  $(21 \pm 8)$  °C within a maximum time span of 15 min, or else the specimens are placed in a water bath at  $(21 \pm 8)$  °C in which the surface of the water covers the specimens by at least 15 mm. The thawing phase lasts a total of 4 h. The water is kept in motion for the entire time and is heated or cooled so that for the entire thawing period the water temperature is  $(20 \pm 2)$  °C in all parts of the freeze-thaw chest or the water tank.

15 min before the end of the 4 h thawing phase the water is pumped out of the freeze-thaw plant in a maximum time of 15 min. If water bath is used the specimens are taken out of the water bath.

The temperature in the center of the reference prism, and the air and water temperatures, are measured and recorded during a freeze-thaw cycle before the first use of the freeze-thaw chest or the frost chest and water tank, and after about every 50 freeze-thaw cycles.

After  $(7 \pm 1)$ ,  $(14 \pm 1)$ ,  $(28 \pm 1)$ ,  $(42 \pm 1)$  and 56 cycles, the following procedure is carried out for each specimen  $(1 \pm 1)$  h before the start of the next freeze-thaw cycle.

- The prisms are removed from the water bath and the surfaces dried with an absorbent towel.

During the period when the samples are out of the water bath and are not being tested they are covered with moist towels.

- The weight of the specimens is determined with an accuracy of 0,1 g.
- The ultrasonic pulse transit time of the specimens is measured according to C.5.1.
- The specimens are returned vertically to the freeze-thaw plant.

### C.7 Expression of results

The value of the internal structural damage is calculated as relative dynamic modulus of elasticity *RDM* after *n* freeze-thaw cycles in percentage for each measurement and each specimen. The *RDM* is rounded to the nearest 1 %.

The mean value, the individual values for each specimen as well as the standard deviation after 56 cycles are used for evaluating the freeze-thaw resistance.

NOTE: The water absorption is additional information to evaluate the internal structural damage. The water uptake is calculated as change in mass  $\Delta m_n$  after *n* freeze-thaw cycles in percentage according to following Equation. The water absorption is rounded to the nearest 0,1 %.

$$\Delta m_n = \frac{m_{28d} - m_n}{m_{28d}} \cdot 100 \quad (\text{C.2})$$

### C.8 Test report

The test report shall, beside the common contents, include at least the following information:

- origin and marking of the specimens,
- concrete identification,
- the mean value and the individual values of the change in mass after  $(7 \pm 1)$ ,  $(14 \pm 1)$ ,  $(28 \pm 1)$ ,  $(42 \pm 1)$  and 56 freeze-thaw cycles,
- the relative values of the freeze-thaw resistance determined for each specimen as well as the mean value in percentage rounded to the nearest 1 %, after  $(7 \pm 1)$ ,  $(14 \pm 1)$ ,  $(28 \pm 1)$ ,  $(42 \pm 1)$  and 56 freeze-thaw cycles,
- visual assessment (cracks, scaling from aggregate particles) before the start and after  $(7 \pm 1)$ ,  $(14 \pm 1)$ ,  $(28 \pm 1)$ ,  $(42 \pm 1)$  and 56 cycles,
- any deviations from these test method.